

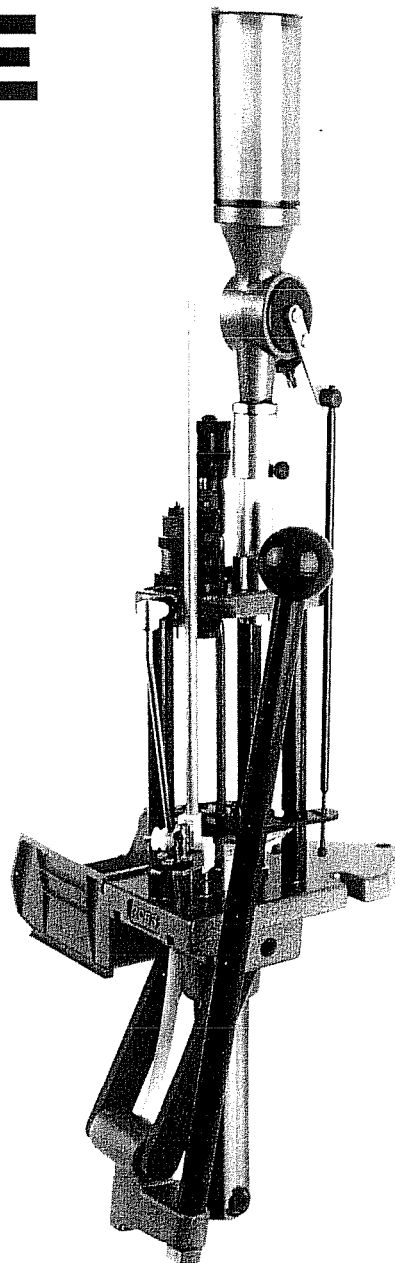

AMMOMASTER-AUTO PROGRESSIVE RELOADING PRESS



Safety and Operating Instructions

IMPORTANT

Before attempting to set up the RCBS AmmoMaster-Auto Progressive Reloading Press read this manual carefully to learn how to safely operate the tool. Failure to properly operate this product can result in severe personal injury and/or equipment damage.

This manual contains specific safety and operating information. It should be considered a permanent part of your reloading tool and, for easy reference, remain with the equipment at all times. **Call us if you have any questions at any time while assembling or operating this tool. Our toll-free phone number is: 1-800-533-5000. Our regular phone number is: (916) 533-5191.**

SAFETY MESSAGE SIGNAL WORDS

This safety symbol, , is used throughout the instruction manual for important safety messages. When you see this symbol, follow the important safety messages to avoid severe personal injury and/or equipment damage.

 **WARNING:** This means severe personal injury, death or property damage can occur if the message is ignored.

 **CAUTION:** This means that minor personal injury or property damage can occur if the message is ignored.

NOTE: This signal word is used to give you helpful installation, operation or maintenance information.

In addition to the safety and operating instructions there is a **HELPFUL HINTS** section included on page 21.

SAFETY

Reloading is an enjoyable and rewarding hobby that is easily conducted with safety. But carelessness or negligence can make reloading hazardous. This product has been designed from the beginning with the user's safety in mind.

As with any reloading operation, some safety rules must be followed. By observing these few rules, the chance of a hazardous occurrence causing damage or injury becomes extremely remote.

GENERAL

- Use the reloading equipment as the manufacturer recommends. Study the instructions carefully and become thoroughly familiar with the operation of the product. Don't take short cuts.
- Observe "good housekeeping" in the reloading area. Keep tools and components neat, clean and orderly. Promptly and completely clean up primer and powder spills.
- Reload only when you can give your undivided attention. Do not reload when fatigued or ill. Develop a reloading routine to avoid mistakes. Avoid haste – load at a leisurely pace.
- Always wear adequate eye protection. You assume unnecessary risk when reloading without wearing safety glasses.
- Remove the operating handle to prevent unauthorized use.

LOADING DATA

- Use only laboratory tested data. We highly recommend the use of the SPEER Reloading Manual.
- **OBSERVE ALL WARNINGS ABOUT THE USE OF MAXIMUM LISTED LOADS.**

PRIMERS AND POWDER

- **WARNING: Primers are designed to explode and will do so when subjected to heat, impact or static electricity.**
- Do not decap live primers.
- Never attempt to seat or reseal a primer in a loaded round.
- Discontinue reloading session when static electricity is noticed.
- Store primers and powder beyond the reach of children and away from heat, dampness, open flames and electrical equipment.
- DO NOT use primers of unknown identity. To destroy unwanted primers, soak in oil for a few days.
- Keep primers in original factory container until ready to use. Return unused primers to the same factory packaging for safety and to preserve their identity.
- DO NOT store primers in bulk. The blast of just a few primers is sufficient to cause serious injury to anyone nearby.
- DO NOT force primers. Use care in handling primers.
- DO NOT use any powder unless its identity is positively known. Discard all mixed powders and those of uncertain or unknown identity.
- If you use a powder measure, replace the lids on

both the powder hopper and powder can after the hopper has been filled.

- Before charging cases, settle the powder in the hopper. Throw and check the weight of at least ten charges. This will assure that the correct powder charge is being thrown.
- After a reloading session ends, pour the remaining powder back in its original factory container. This will preserve the identity and shelf-life of the powder.
- DO NOT smoke while handling powder or primers.

RECORD KEEPING

- Keep complete records of reloads. Apply a descriptive label to each box showing the date produced, and the primers, powder and bullet used. Labels for this purpose are packed with SPEER bullets.

Since RCBS has no control over the choice of components, the manner in which they are assembled, the use of this product or the guns in which the resulting ammunition may be used, no responsibility either expressed or implied, is assumed for the use of ammunition reloaded with this product.

GENERAL INFORMATION

The RCBS AmmoMaster-Auto has all the features of a five station fully automatic progressive reloading press including: Automatic indexing, priming, powder charging and loaded round ejection. The popular Uniflow Powder Measure is included with the AmmoMaster-Auto for precise powder charges. A five-station shell plate (numbered the same as standard RCBS shell holders) and reloading dies are not provided with the AmmoMaster and must be purchased separately. Because the AmmoMaster takes standard 7/8x14 reloading dies you can use that "favorite set" of dies or switch calibers quickly.

AmmoMaster also has a unique case detection system that disengages the powder measure when no case is present in the powder charging station. This system eliminates the possibility of inadvertently throwing a charge and still allows the reloader to use the dependable Uniflow Powder Measure. The Uniflow has long been known for its dependability, repeatability and capability for throwing a broad range of powder charges.

The press also comes with a clear powder measure adaptor. Although there is no method for preventing bridging when stick powders are used, the clear adaptor makes the bridging visible and correctable before a bad round is completed. A light tap on the clear adaptor will dislodge the bridged powder. With the AmmoMaster you can enjoy the speed of progres-

sive reloading without having to give up your favorite stick powders.

The AmmoMaster can be configured to be a manually indexed or automatically indexed progressive press. If the reloader prefers to index manually, a handy "star" wheel does the job. If you prefer auto indexing, it is accomplished by an indexing rod/one way clutch bearing and locating pin.

UNPACKING

Refer to the parts list on page 25 for the proper identification of parts. There are three bags, numbered 1 through 3, containing small parts that are required to complete the assembly of the AmmoMaster-Auto. We suggest opening only the bag that is required as you assemble the AmmoMaster-Auto according to the following instructions. Remember, if you need additional help or replacement parts, call RCBS. Our toll-free phone number is: 1-800-533-5000. Our regular phone number is: (916) 533-5191.

ASSEMBLY AND INSTALLATION

You will need the following tools for easier assembly and installation of the AmmoMaster:

- Adjustable wrench
- Long-nose pliers
- Hardware for mounting press

STEP 1

The AmmoMaster must be securely bolted to a sturdy bench, using the three mounting holes in the base of the press. The bolts must reach through the bench and be secured with washers and hex nuts. Failure to do so can result in equipment damage or serious personal injury. Refer to the template on page 26 for a mounting guide.

STEP 2

Install the threaded portion of the operating handle through the toggle block. Attach the handle nut and tighten firmly with a wrench. The handle nut must remain tight at all times to avoid damage to the handle and toggle.

PRIMING SYSTEM AND SHELL PLATE INSTALLATION

Open Bag #2 and Bag #3 and check them against the parts below and on the following page. All the parts necessary to change priming systems and to mount the shell plate are in Bag #2. Included in Bag #3 (see below) are the hex key wrenches necessary for certain adjustments, and three die lock rings which will be discussed in a later section.

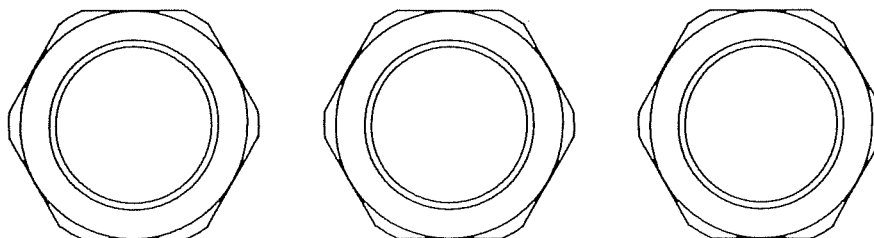
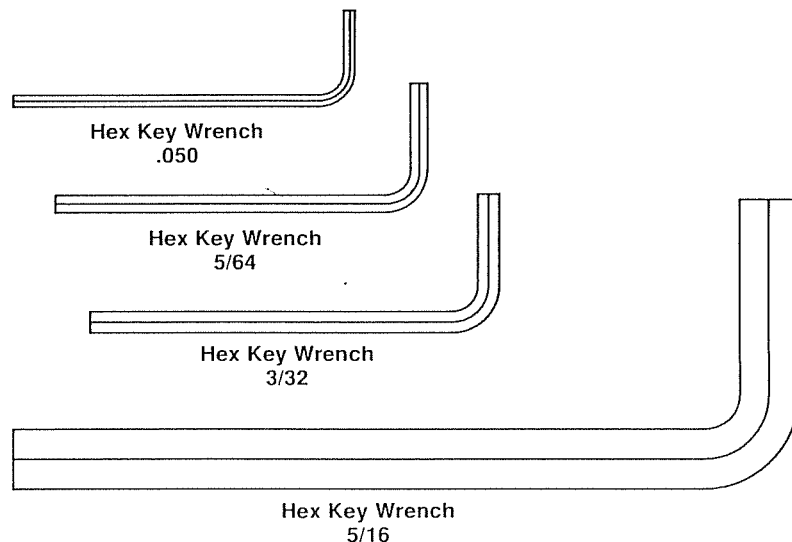



Ram Return Spring

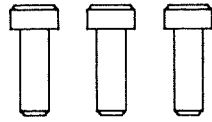

Case Retaining Spring Plug

Primer Dispenser - Large

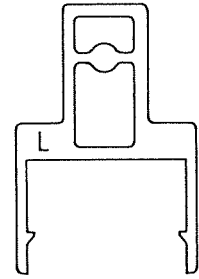

Primer Plug Spring



Index Ball

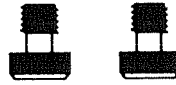

Knurled Screw 8 - 32

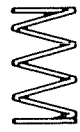

Index Ball Spring



Primer Plug Clip



Primer Plug - Large

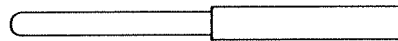

Primer Follower

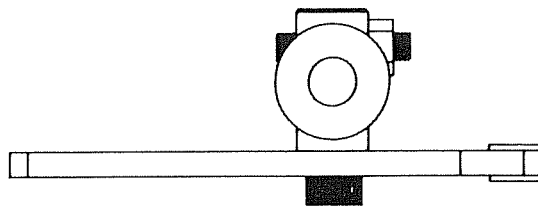

Transfer Bar Assembly

The small priming system was installed at the factory. If the caliber you will be loading requires large primers, replace the small priming system following these steps. But first, clean any oil from the large transfer bar and plug. Then, remove the small primer plug, transfer bar and primer dispenser from the tool.

STEP 1

Drop the primer plug into the shell plate holder. See Photo #1. Raise the ram approximately half way through the stroke. Slide the spring over the bottom of the primer plug and compress the spring with your finger. Using a pair of long-nose pliers, install the hairpin clip in the groove of the plug. See Photo #2.

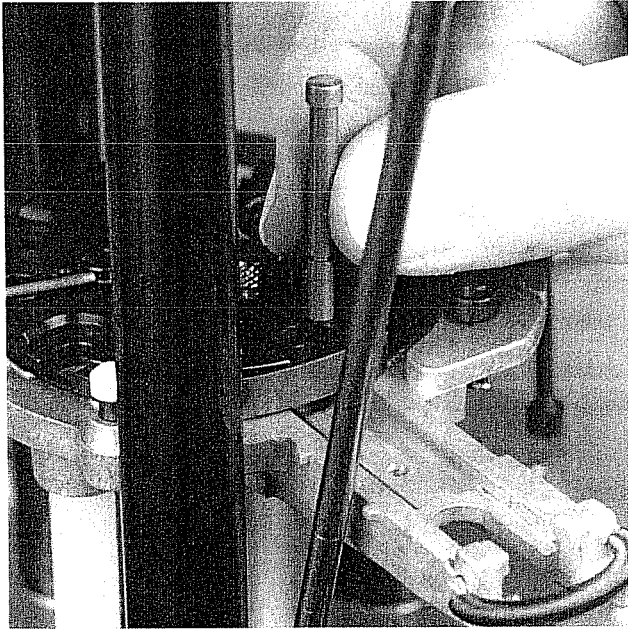

Photo #1: Drop the primer plug into the shell plate holder.

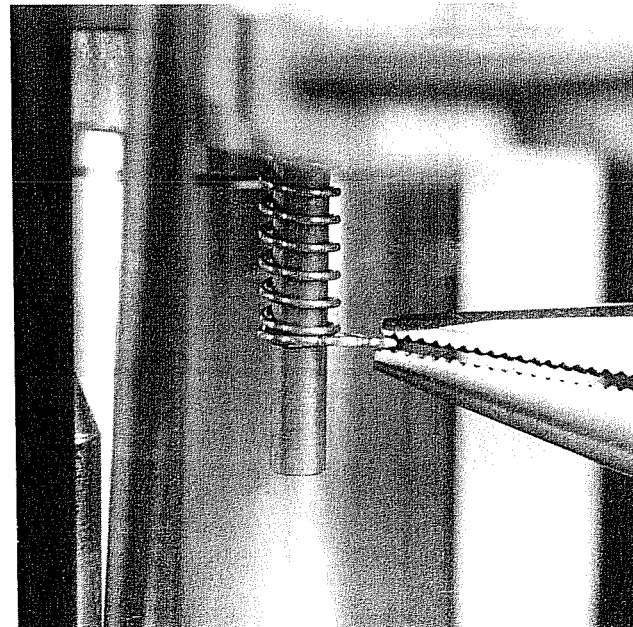

Photo #2: Install the hairpin clip in the groove in the plug.

STEP 2

The AmmoMaster is supplied with two primer dispensers; one for small primers (stamped with an "S" on the front) and one for large primers (stamped with an "L" on the front). The small dispenser is installed at the factory. If the caliber you will be loading requires large primers, replace the small dispenser following these steps (make sure the ram is up): Select the proper size primer dispenser and snap it onto the shell plate holder with the "S" or the "L" facing out. Make sure it locks firmly in place. See Photo #3. The primer dispenser must be firmly seated on the shell plate holder. If raised even slightly, primers will hang-up under the primer dispenser and fail to feed. Also, if the primer dispenser becomes loose, bend the legs inward to tighten the grip on the shell plate holder.

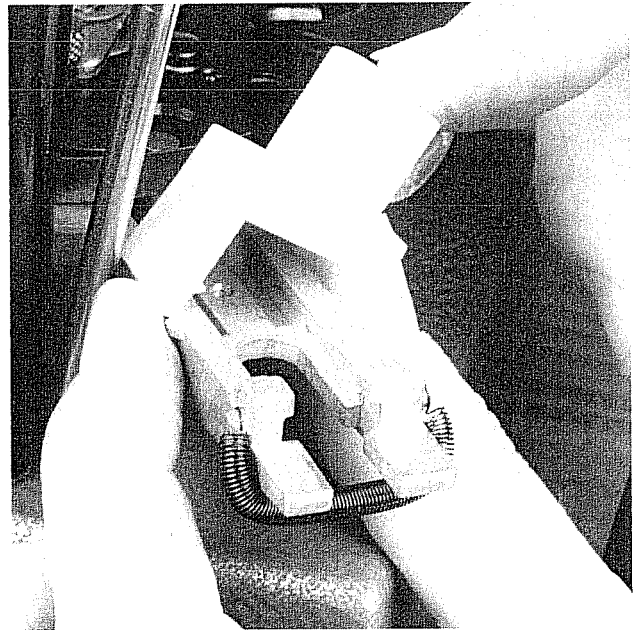

Photo #3: Install the primer dispenser onto the shell plate holder.

STEP 3

Select the proper primer transfer bar assembly. They are stamped on the bottom with an "S" for small primers or an "L" for large primers. Slide the transfer bar into the primer slot in the shell plate holder. See Photo #4. Slip the return spring over the two ears on either side of the primer slot on the shell plate holder and over the back of the primer transfer bar assembly. See Photo #5.

TRANSFER BAR ADJUSTMENT

Primers are transferred from the primer tube to the primer plug by the cam wire and the return spring. The transfer bar is adjusted at the factory. Check to be sure the following two adjustments have not been altered in transit.

ADJUSTMENT #1

Raise the ram approximately 1/8" until the top of the primer plug is flush with the transfer bar. The primer plug should be centered in the hole of the transfer bar. To adjust the transfer bar over the primer plug, loosen the hex nut and turn the setscrew on the roller carrier until the hole in the transfer bar is centered over the primer plug. See Photo #6. This can be done visually. Hold the setscrew with the hex wrench and tighten the hex nut. See Photo #7. The primer plug should move freely in and out of the transfer bar as the AmmoMaster is cycled. If you hear or feel the plug rubbing against the transfer bar, it is not centered correctly and needs adjustment. Remember, the primer plug **must be centered** in the transfer bar hole.

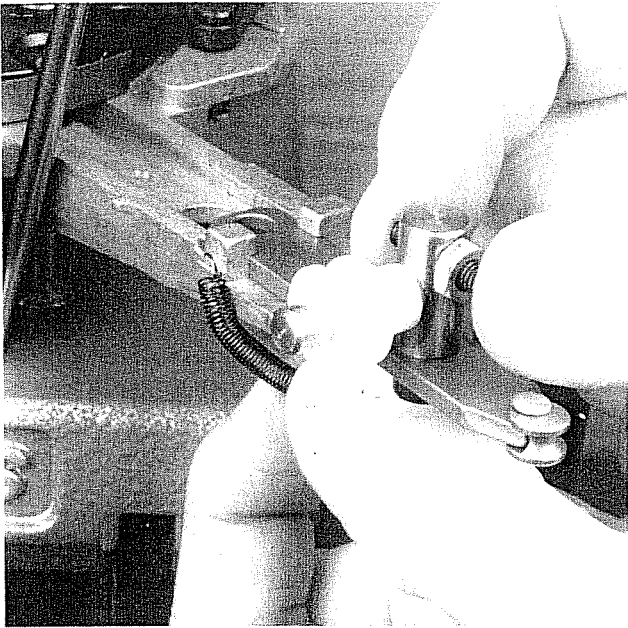

Photo #4: Slide the transfer bar into the priming slot.

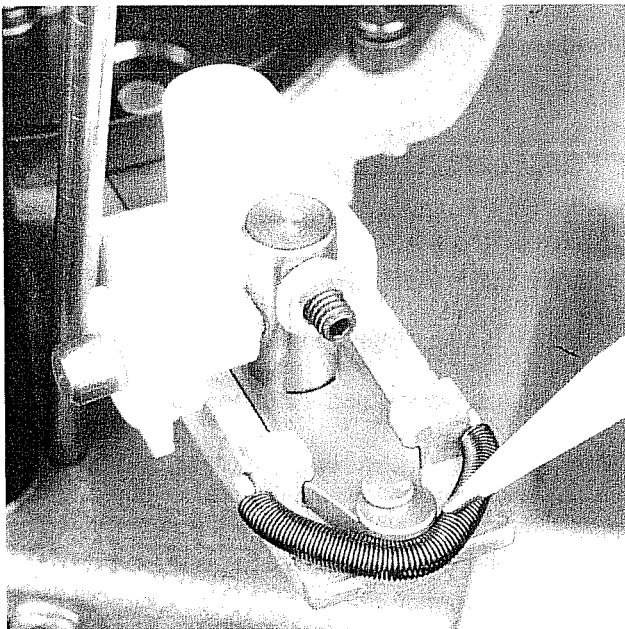

Photo #5: Position the spring over the back of the transfer bar assembly.

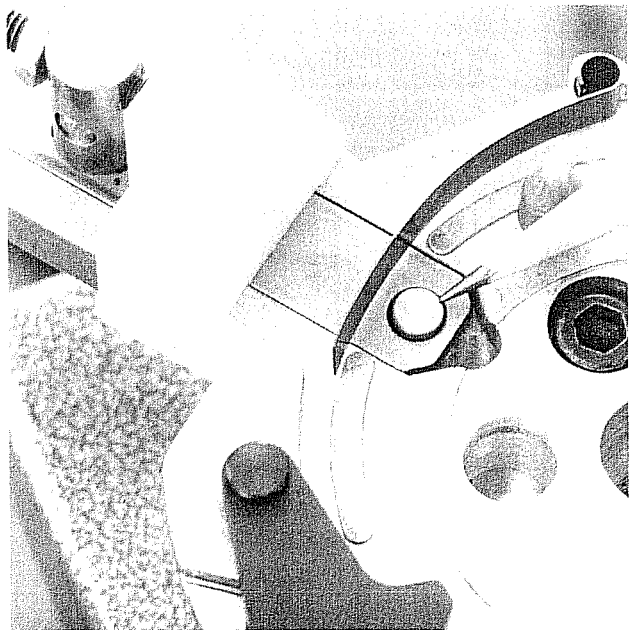
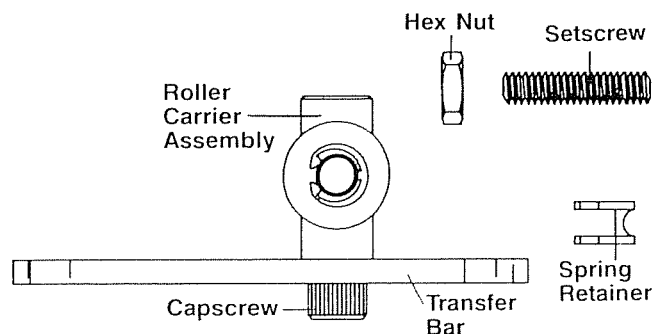

Photo #6: The primer plug must be centered in the transfer bar hole.



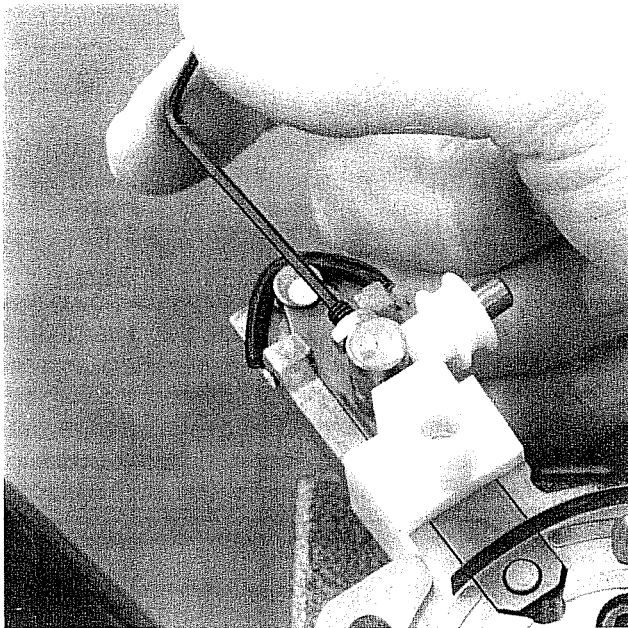

Photo #7: Hold the setscrew and tighten the hex nut.

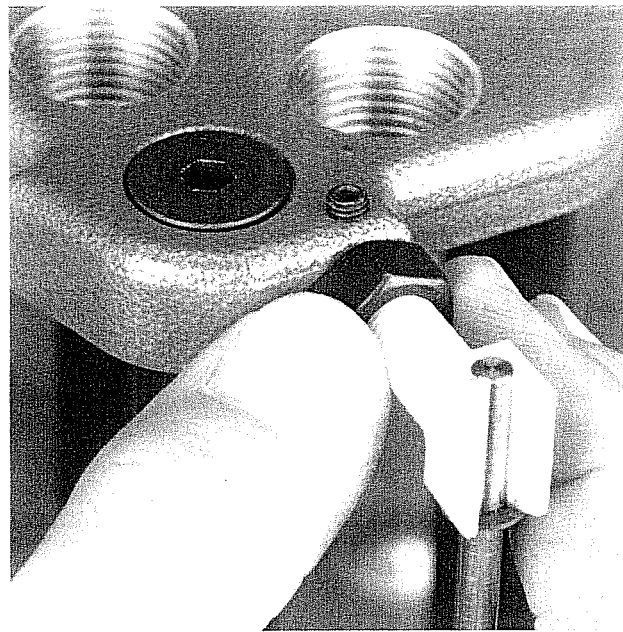

Photo #9: Turn the nut clockwise 1-1/2 to 2 turns.

ADJUSTMENT #2

The cam wire adjustment is made at the factory and should not need adjustment. Follow these steps if your AmmoMaster fails to pick up primers smoothly from the dispenser. To adjust the transfer bar at the primer dispenser, raise the ram to the top of the stroke. Loosen the cam wire clip setscrew and the nut on the clip located in the top plate. See Photo #8. Push in on the clip until it bottoms out in the hole. Turn the nut on the clip until it makes contact with the top plate. Then, turn the nut clockwise 1-1/2 to 2 turns. See Photo #9.

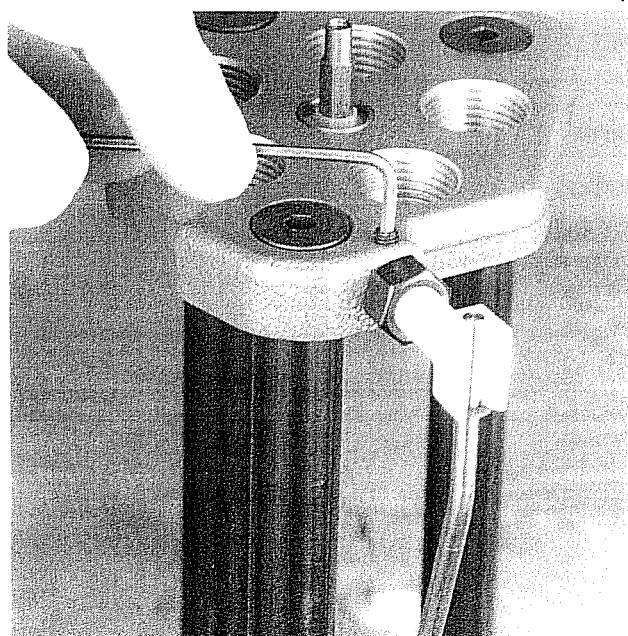

Photo #8: Loosen the setscrew in the top plate.

Tighten the setscrew and the adjustment is complete. Refer to this section for adjustment if there is a problem with Step 1 on page 19 under "Press Operation."

STEP 4

Cycle the press several times to insure the transfer bar is adjusted correctly and become familiar with this operation. **NOTE:** The cam wire is designed to snap free if there is a jam with the transfer bar. The primer dispenser is also designed to pop free if there is a jam with a primer. The most likely cause for a jam is incorrect adjustment under the shell plate or debris under the primer plug.

Refer to the **Helpful Hints** and **Trouble Shooting** sections in the back of this manual or call us at the factory.

Our phone numbers are listed on the back of this manual.

AN EXPLANATION OF THE INDEXING SYSTEM

The automatic indexing system on the AmmoMaster is quite simple and reliable. The hexagonal rod has a 72° twist approximately two inches from the top. As the rod moves up and down with the ram action, the twist passes through the nylon bushing and bearing in the top plate. On the up stroke, the nylon bushing rotates counter clockwise as the twist passes through it. On the down stroke, the one-way clutch bearing prevents the nylon bushing from rotating and the twist causes the shell plate to rotate to the next station.

In normal operation, a small amount of resistance will be felt as the twist travels through the bushing in either direction. This resistance is normal. A nylon bushing is used to protect the indexing system against misuse. If the system is forced when jammed, the bushing will be stripped and thus, protect the bearing and index rod from damage.

If the ram travel is reversed part way through the twist, indexing will be incomplete and the shell plate stations will stop in the wrong locations. When this occurs, leave the handle in the up position with no pressure on it and, using your fingers, manually advance the shell plate in a counter clockwise direction to the next station. The system is now correctly aligned for continued use.

To avoid incomplete indexing, always continue ram travel through the twist area of the index rod in both directions.

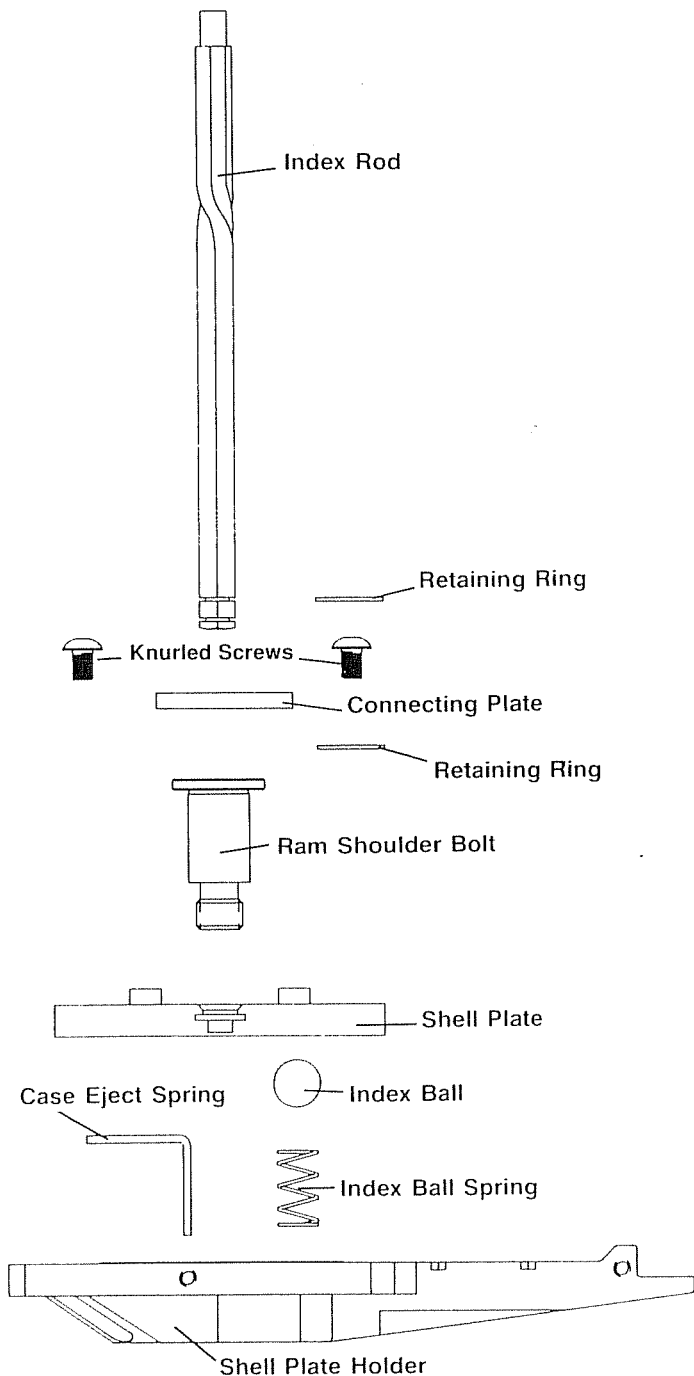

⚠ CAUTION: If the ram travel is not complete, a powder charge may not be delivered. Set aside any cartridge which might not have a powder charge. The optional RCBS Powder Checker will assist in spotting cartridges which did not receive a powder charge.

⚠ CAUTION: Do not try to index the press if abnormal resistance is felt. This can damage the nylon index bushing. Check the AmmoMaster for a problem and correct it before proceeding. Refer to the TROUBLE SHOOTING section on pages 21 and 22.

NOTE: Damaging the index rod will cause excess wear of the index bushing. Do not use pliers or other tools on the index rod.

NOTE: The indexing system operates in one direction (counter clockwise) only. Trying to turn the system in the clockwise direction will damage the indexing system.

STEP 1

The AmmoMaster uses a five-station shell plate that has the same numbering system as RCBS shell holders. Shell plates are available for a variety of popular calibers. Consult the Shell Plate Chart on page 23 for the proper shell plate number.

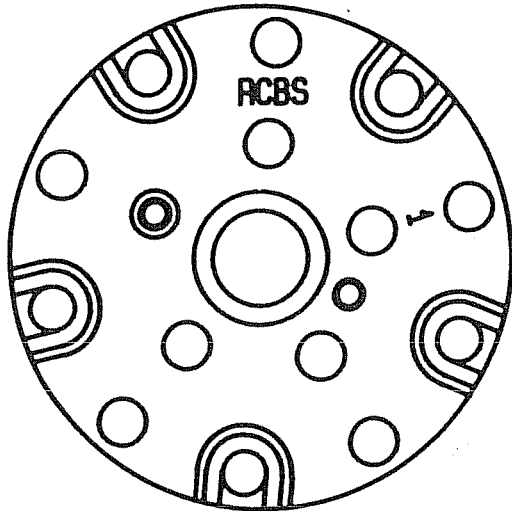

STEP 2

The ram shoulder bolt was installed at the factory and must be removed before proceeding. Insert the index ball spring into the hole in the shell plate holder. See Photo #10. Place the index ball on top of the spring. See Photo #11. To more clearly show this step, we have removed the three support rods from the AmmoMaster.

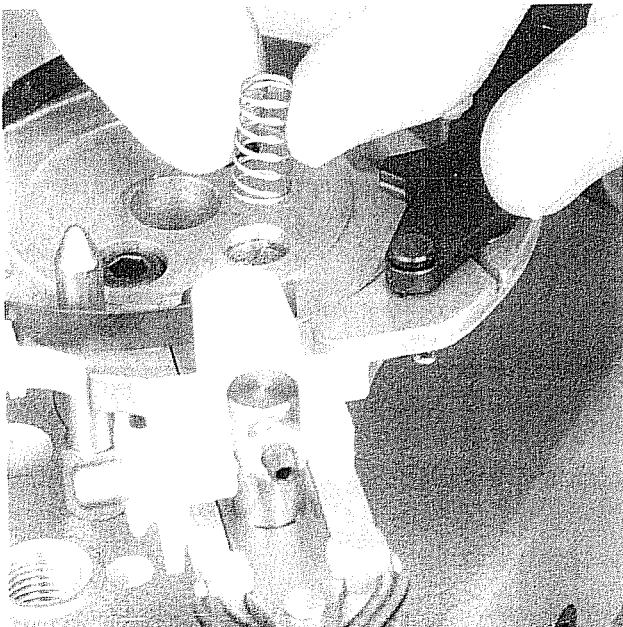

Photo #10: Insert the index ball spring into the hole.

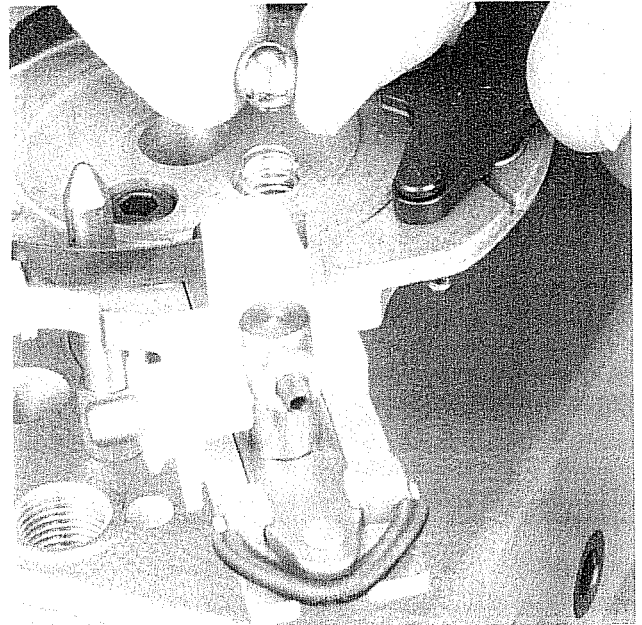

Photo #11: Place the index ball on top of the spring.

STEP 3

The easiest way to install the shell plate is to raise the shell plate holder up so it clears the shell plate locating pin. Place a 1-1/2" spacer (like a wooden block or a fired .38 case) under the shell plate holder to hold it up. Place the shell plate on the shell plate holder from the left side. See Photo #12. Position the case detection arm into one of the shell holder slots on the shell plate. Press down on the shell plate to compress the case detent ball and spring. Be sure the case retaining springs are on the outside of the shell plate.

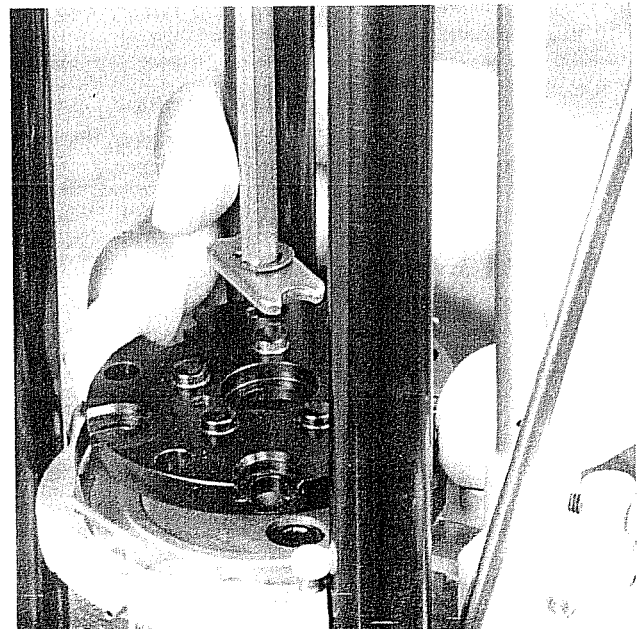

Photo #12: Place the appropriate shell plate on the holder.

Install the ram shoulder bolt through the shell plate. See Photo #13. Tighten the bolt with the hex wrench provided. The shell plate should rotate smoothly and stop at each station. Pull down on the operating handle and remove the wooden block used to raise the shell plate holder. Install the three case retaining spring plugs in the holes of the case retaining springs. See Photo #14.

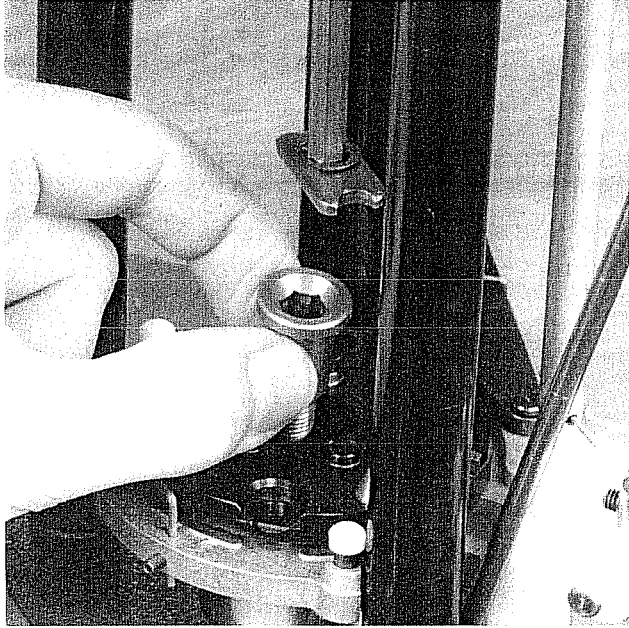

Photo #13: Install the ram shoulder bolt through the shell plate.

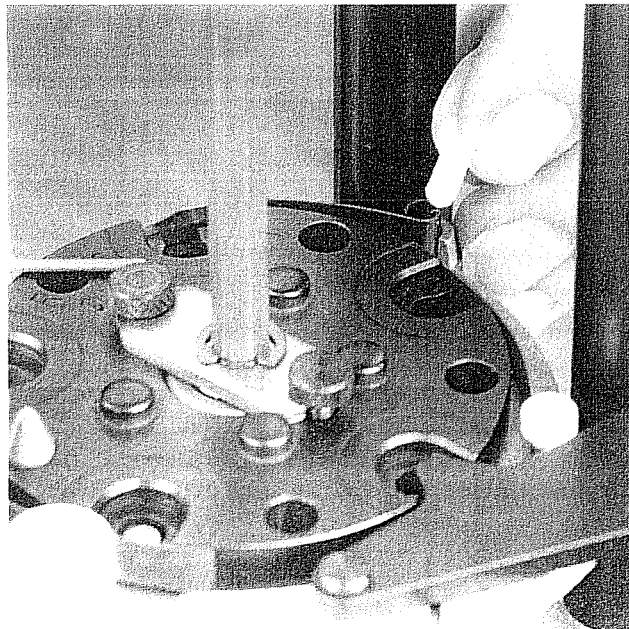

Photo #14: Insert the case retaining spring plugs.

As the ram travels up and down, the locating pin will pass through the shell plate. If it does not, rotate the plate until the pin aligns properly.

STEP 4

FOR AUTO INDEXING: Lower the hex index rod with the connecting plate to the shell plate. The connecting plate is offset. Rotate the connecting plate counter-clockwise until the large notch in the plate aligns with the raised bump with the threaded hole on the shell plate. Insert the knurled connecting plate screws into the threaded holes in the shell plate and tighten. See Photo #15.

NOTE: Finger tight is adequate but it is important that they stay tightened. Excessive tightening can cause malfunctions.

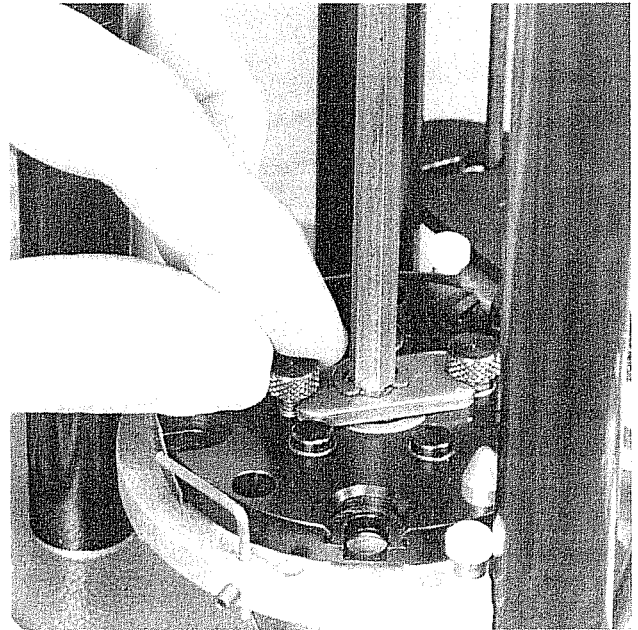

Photo #15: Securely fasten the connecting plate with the knurled screws.

FOR MANUAL INDEXING: First, remove the connecting plate and index rod that was installed at the factory. To do this, remove the two clip springs on the top and bottom of the connecting plate and pull the index rod out through the top of the press. Next, place the five holes of the star wheel over the five bumps on the shell plate. See Photo #16. Secure the star wheel with the two knurled screws that would be used to hold the connecting plate. See Photo #17. Now, place the ram return spring over the shell plate locating pin. See Photo #18. Push the spring down so it is flush with the base of the press. The star wheel and the spring are only used with manual indexing. They are not used for auto indexing. Advance the star wheel with your finger to learn how it operates. See Photo #19.

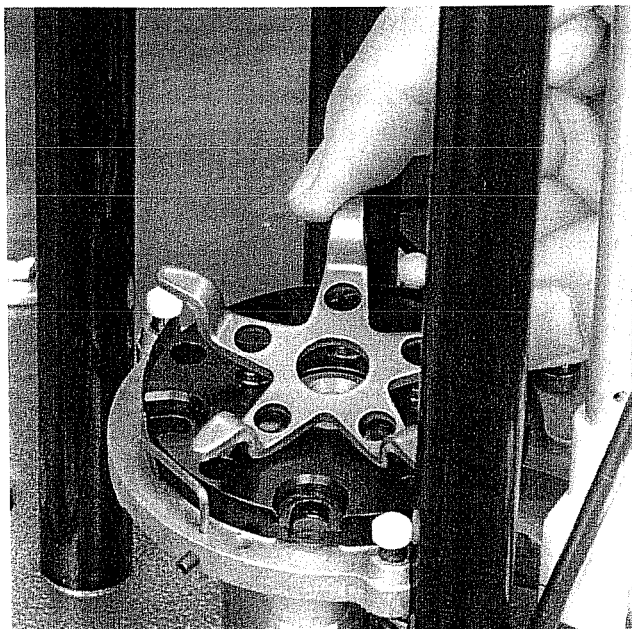

Photo #16: Place the star wheel on the shell plate.

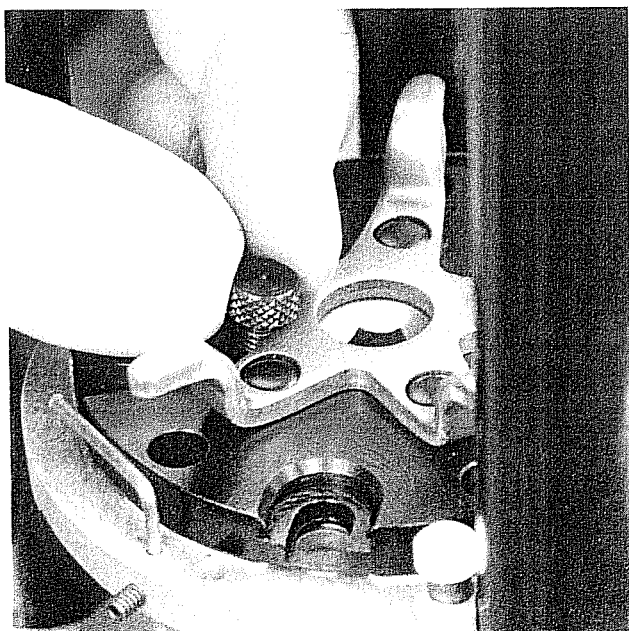

Photo #17: Secure the star wheel with the knurled screws.

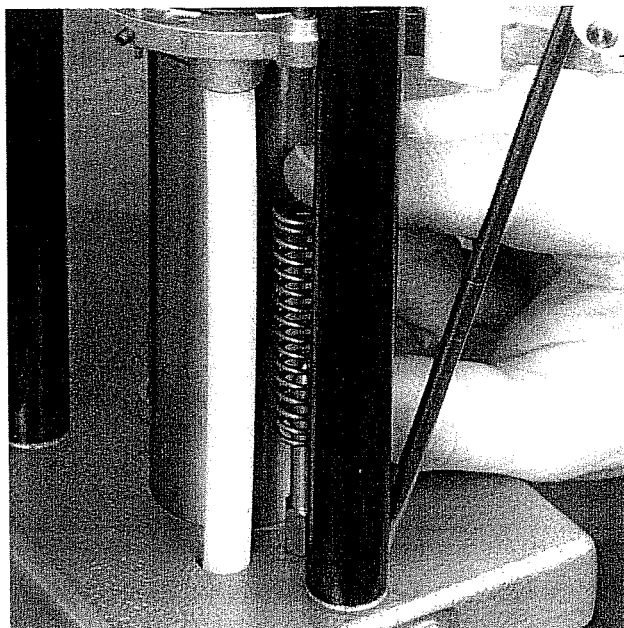

Photo #18: Place the return spring over the locating pin.

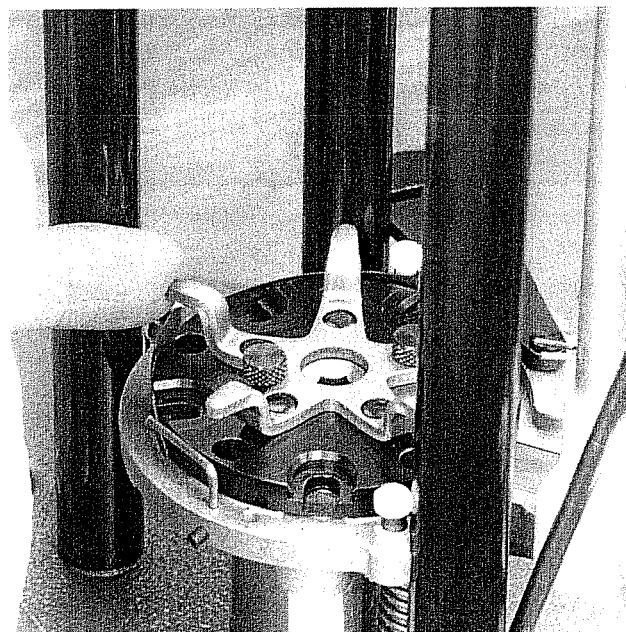

Photo #19: Advance the star wheel with your finger.

STEP 5

FOR AUTO INDEXING: The operating handle can now be cycled. As the handle is being raised and the shell plate is nearing the bottom of the stroke, the shell plate will index one station at a time. The index locating pin should locate and engage the shell plate. If the pin doesn't engage the shell plate, the plate is out of time. Simply turn the plate by hand until the detent ball stops the plate and the case detection arm slips into the case holder slot. Lower and raise the handle the entire stroke. The shell plate should index properly.

⚠ CAUTION: To avoid incomplete indexing, the twisted portion of the index rod must pass completely through the index bushing.

FOR MANUAL INDEXING: As the handle is raised and lowered observe the locating pin in relation to the locating pin hole.

STEP 6

Straighten the white plastic spent primer tube by bending it slightly with your hands. To assemble the depriming bottle and spent primer tube, insert the white plastic tube (with a slight twisting motion) into the top of the depriming bottle cap. Slide the other end of the tube behind the toggle block and through the hole in the bottom of the AmmoMaster base. Screw the tube into the shell plate holder at station #1. See Photo #20.

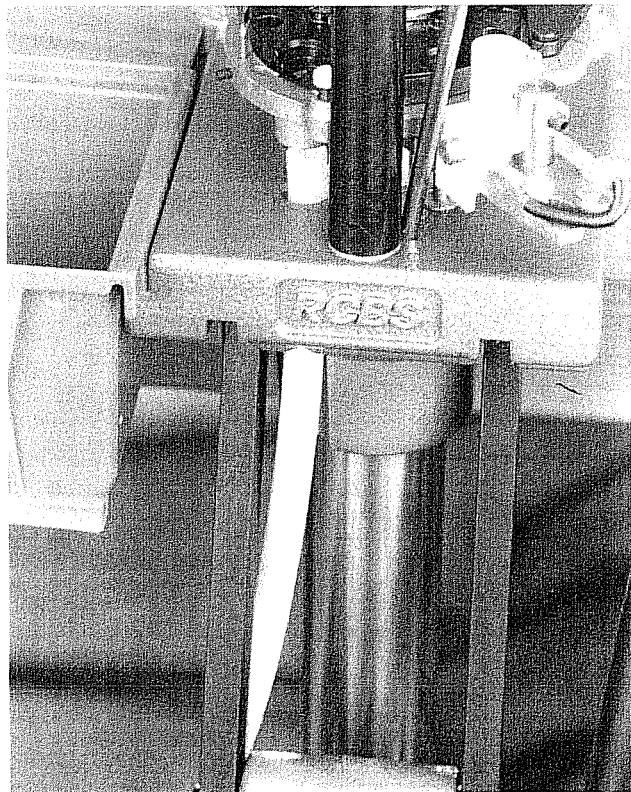

Photo #20: Install the spent primer tube.

STEP 7

The ammo catcher box mounts on the left side of the press. The lip on the box slides into the slot. See Photo #21.

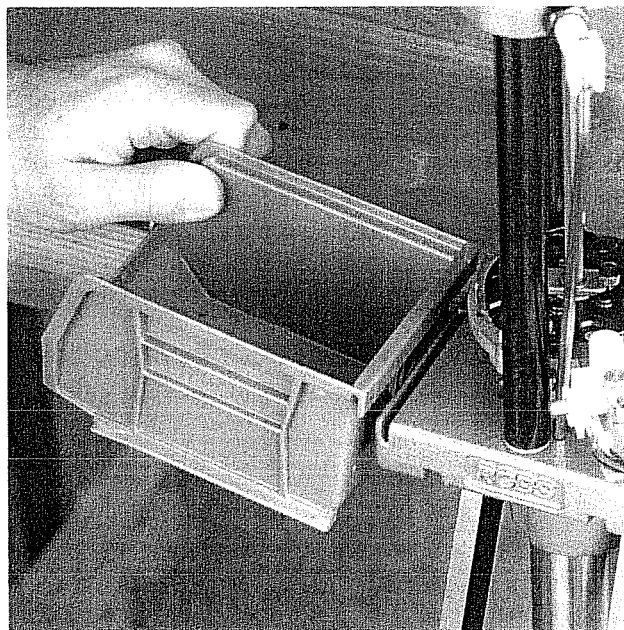
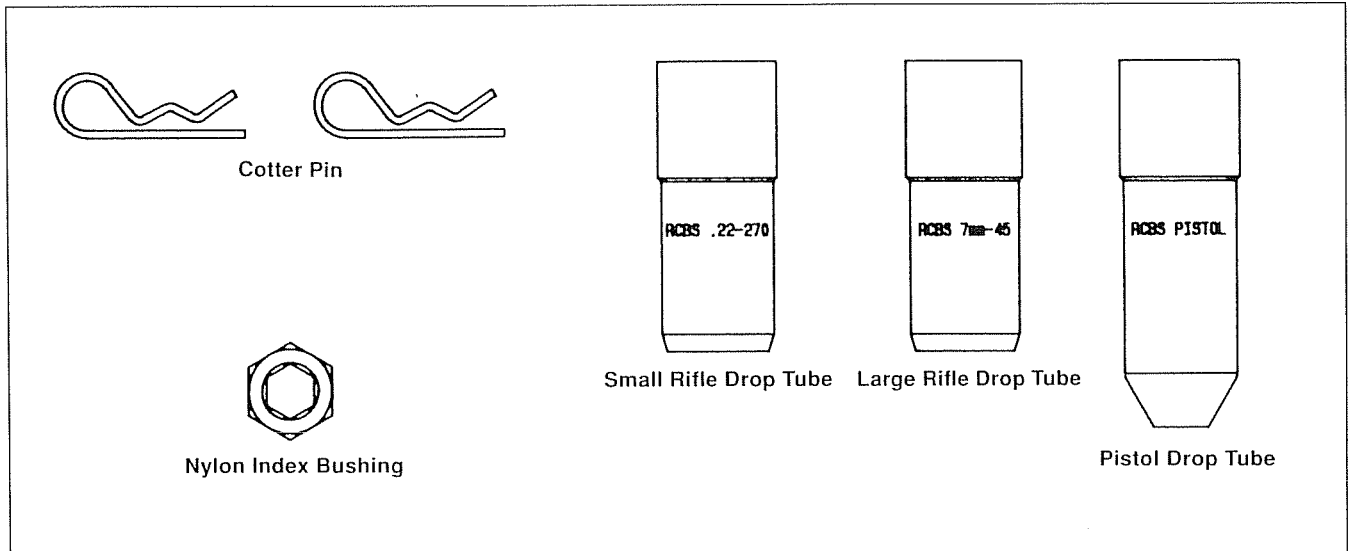

Photo #21: Install the ammo catcher box.

POWDER DISPENSING SYSTEM

The parts needed to complete the assembly of the powder dispensing system are in Bag #1. Open Bag #1 and check the parts against the drawing.



STEP 1

The clear plastic powder measure adaptor has been installed in Station #3. The adaptor must be removed (by unscrewing with your hands . . . no pliers) for cleaning. **Clean the powder measure adaptor with soap and luke warm water and dry thoroughly. It must be absolutely free of any oil.** Use a 20 gauge shotgun swab to clean and dry the adaptor. **NOTE:** Do not use spray solvents on plastic parts. Thread the powder measure adaptor back into station #3. See Photo #22. Hand-tighten the adaptor all the way down. **Do not use any tools to tighten the adaptor.**

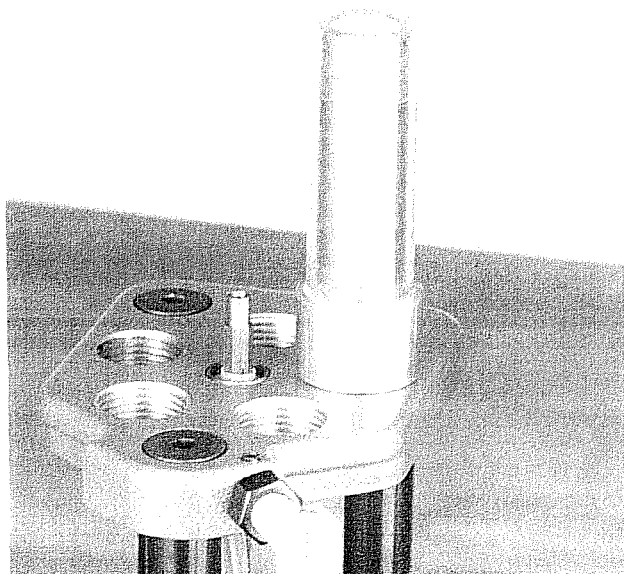

Photo #22: Thread the plastic powder measure adaptor into station #3.

STEP 2

Select the proper powder drop tube. The drop tubes are stamped with the caliber range. Thoroughly clean the drop tubes, inside and out using soap and water, solvent or alcohol. **NOTE:** Oil will contaminate gun powder and cause the powder to jam the operation of the powder dispensing system. Insert the drop tube into the adaptor with the small end down. See Photo #23. It will drop freely until it is stopped by the bottom shoulder on the inside of the adaptor. Move the drop tube up and down to insure it is not binding in the adaptor.

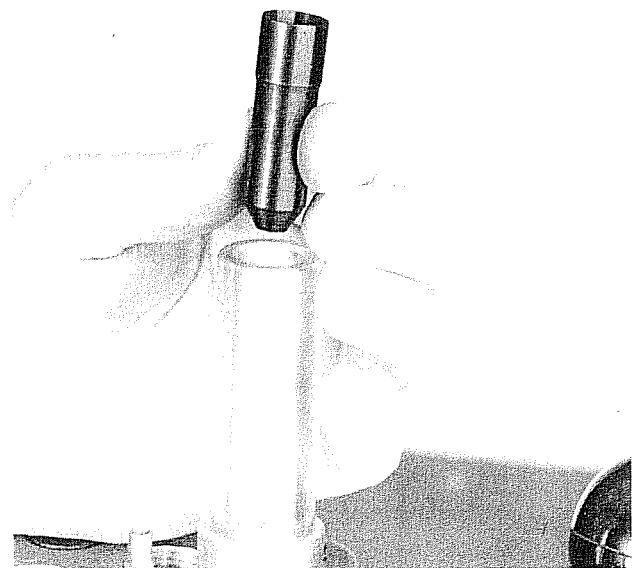

Photo #23: Insert the drop tube into the adaptor.

STEP 3

The Uniflow Powder Measure Cylinder, Metering Screw and Casting must be disassembled and cleaned. These parts are dipped in a preservative oil and must be thoroughly cleaned. **Do not use spray solvents to clean the plastic hopper.** These solvents can cause the powder hopper to break. The quick-change collar on the powder measure was installed at the factory and should remain in place while cleaning. If you find it necessary to remove the quick-change collar, make sure it is replaced as shown in the photograph. The thumb screw should be almost directly under the spring tab. See Photo #24. Note the location and number of threads in the photo. Reassemble the powder measure after cleaning. The powder measure return spring must not touch the connecting yoke.

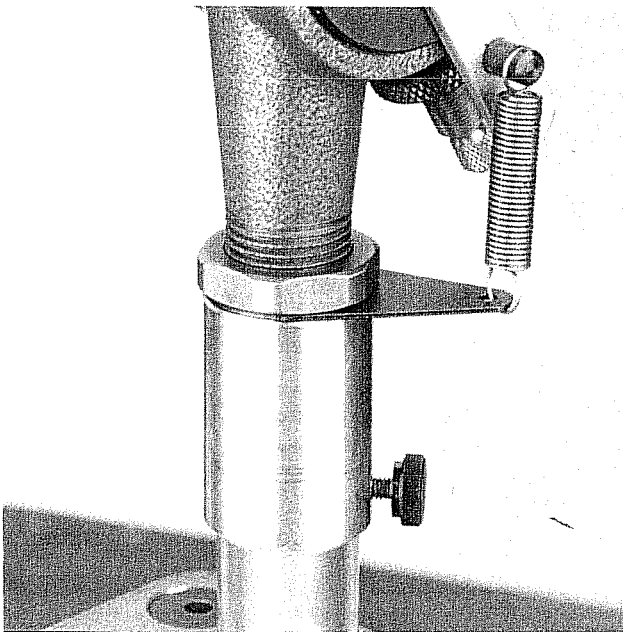

Photo #24: Position the thumb screw so it is under the spring tab and away from the index rod.

STEP 4

Slide the powder measure onto the powder measure adaptor. See Photo #25. Do not tighten the lock screw on the quick change collar.

STEP 5

The case detection push rod should be installed at this time. The rod (with the long small diameter) should be slipped into the keyhole in the case detection arm. The other end (with the connecting yoke that swivels) should be connected to the powder measure arm and secured with the cotter pin. See Photo #26.

The case detection arm on the shell plate holder will detect a case at the powder charging station. When a case is present, the arm pivots and engages the powder measure. If no case is present, the arm doesn't engage the powder measure and no powder charge is thrown.

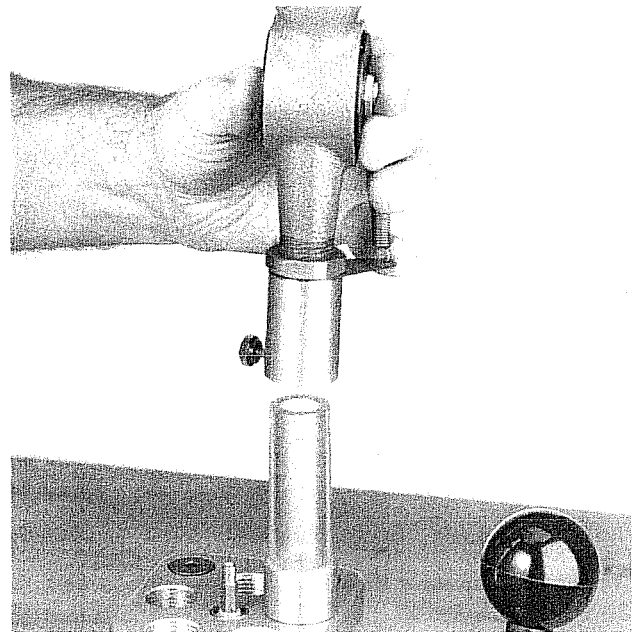

Photo #25: Slide the powder measure onto the adaptor.

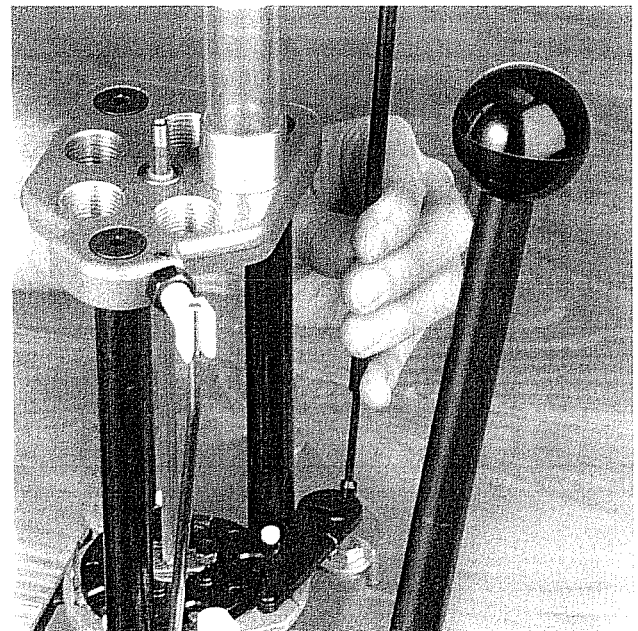

Photo #26: Install the case detection push rod.

STEP 6

Now you are ready to adjust the powder measuring system. Adjust the powder measure with the shell plate empty. The powder measure must be rotated until the push rod is centered in the large diameter of the key hole in the case detection arm. See Photo #27. Tighten the quick change collar thumb screw. **Do not over-tighten.**

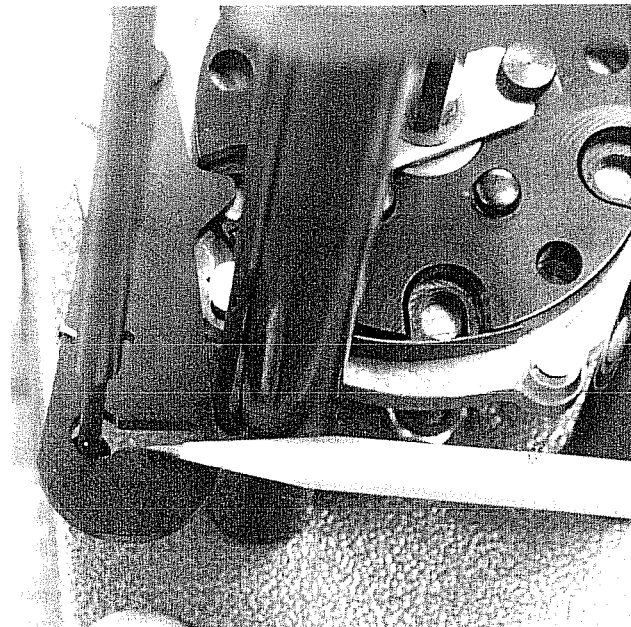

Photo #27: Position the powder measure to center the push rod in the case detection arm.

This is an excellent time to test the adjustment of the powder measuring system. Place a fired case in the shell plate at station #1 and cycle the press. Notice how the powder system works. When a case is not present at station #3, the case detection arm doesn't engage the powder measure. As the fired case reaches station #3, watch the case detection arm rotate and engage the powder measure. See Photo #28. The powder measure will cycle as the press is cycled. When you are satisfied with the operation, refer to the note below.

NOTE: It is a good idea to mark the quick change collar and the powder measure adaptor with a matching line. This makes it handy to locate the powder measure in the right location when it is removed.

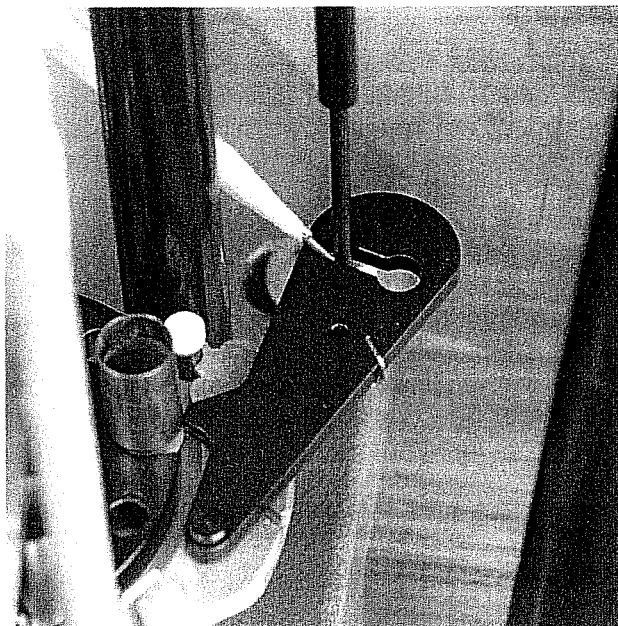

Photo #28: Notice how the case detection arm rotates and engages the push rod.

STEP 7

⚠ WARNING: The operator is solely responsible for all aspects of the powder dispensing system. Either an insufficient or excess powder charge can result in gun damage and serious personal injury.

⚠ WARNING: Be certain that the correct type of powder is used and that the powder measure does not run out of powder. Confirm on an accurate reloading scale that the correct charge is being dispensed.

⚠ WARNING: Be absolutely certain that only one charge is dispensed into each cartridge. No more, no less. If in doubt, check the case powder charge prior to seating the bullet. Refer to the latest SPEER Reloading Manual for safe powder handling and storage instructions.

⚠ WARNING: The "flow" characteristics of powder varies considerably due to weather, operator technique and other factors inherent to the powder itself. Long and/or large granulated powders may tend to "bridge" in the powder drop system and cause erratic charge weight. Again, the clear powder measure adaptor makes the bridging visible and, with a light tap, the bridged powder can be dislodged. Be certain that the powder you select flows freely through the powder dispensing system. We recommend that ball powder should be used in all progressive reloading tools.

Powder may now be added to the powder measure hopper. Adjust the powder measure for the proper charge. Refer to the Uniflow Powder Measure instruc-

tions. While adjusting the powder measure, place a fired case (with a spent primer) in the shell plate and cycle the case over to station #3. Cycle the press and dispense a powder charge into the case. Cycle the case over to station #4 and remove the case from the shell plate. Weigh the powder charge on a reloading scale. Continue this until the proper powder charge is achieved. Then, repeat this process a couple of times to ensure you are dispensing the proper powder charge. Check the powder charge occasionally while you reload to ensure you are getting the proper powder charge. Again, the optional RCBS Powder Checker will assist in spotting cartridges which did not receive a powder charge.

NOTE: The use of long and/or large granulated powders is not recommended. If you are using these powders, you must watch the powder measure adaptor for bridging of powder. Slowing the press stroke as it begins to dump powder will allow large powder charges adequate time to flow into the case. In case of "bridging" you will have to give the powder measure adaptor a light tap for the powder to flow. A close eye must be kept on the powder measure adaptor if you are using long grain powders.

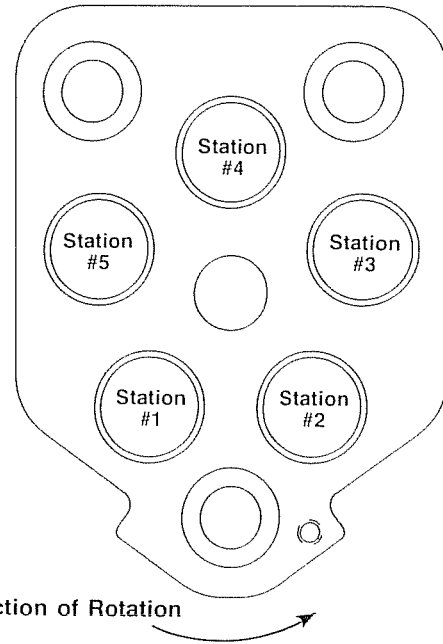

GENERAL ORIENTATION

The sequential reloading operations take place in the five die stations and corresponding positions in the shell plate. The shell plate rotation is in the counter-clockwise direction. Shown below is a chart that outlines the different operations that take place at each shell plate station.

| Station | Bottle-neck Cases | Bottle-neck Cases with Lube Die |
|---------|---------------------------|---------------------------------|
| #1 | Size & Deprime | Lube & Deprime |
| #2 | Prime | Size & Prime |
| #3 | Powder Charge | Powder Charge |
| #4 | Skip Station | Skip Station |
| #5 | Seat (& Crimp*) Bullet | Seat (& Crimp*) Bullet |

*Only with Bullets with Cannelure.

| Station | Straight-Wall Cases with combined bullet seating & crimping | Straight-Wall Cases with separate bullet seating & crimping |
|---------|---|---|
| #1 | Size & Deprime | Size & Deprime |
| #2 | Prime & Expand Case Mouth | Prime & Expand Case Mouth |
| #3 | Powder Charge | Powder Charge |
| #4 | Skip Station | Seat Bullet |
| #5 | Seat & Crimp Bullet | Crimp Bullet |

DIE INSTALLATION

Refer to the instructions received with your reloading die set for the proper installation of the dies in the press. Adjust the dies the same as you would in a single stage press. See Photo #29. The press is designed to use dies with steel hex lock rings only. Some older RCBS dies were manufactured with knurled aluminum lock rings. These lock rings will not fit on a five-station top plate. This is why we have included three hex lock rings. Additional rings are available from your dealer or call RCBS.

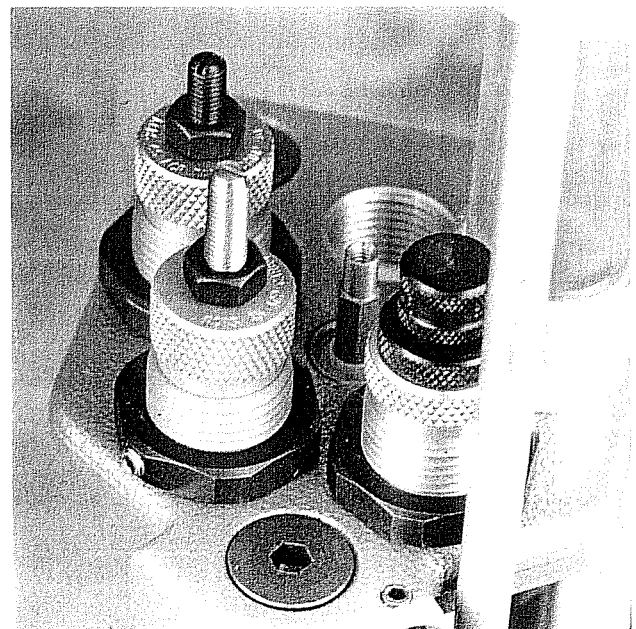

Photo #29: Install and adjust the reloading die set.

PRIMER FEED TUBE FILLING

⚠ WARNING: Care must be taken when loading the primer feed tube. Do not force primers. Because of the stacked condition of the primers, if one should ignite, all the primers in the tube will explode causing an extreme hazard. No more than five pounds of force should be applied when picking up primers with the primer feed tube (this can be checked using a bathroom scale). If difficult primer pick-up should occur, investigate the cause and clear the condition or return the primer feed tube to RCBS for correction. Always wear eye protection when handling primers.

We recommend the primer feed tubes be used in conjunction with the RCBS Primer Tray. This plastic primer tray and cover have been designed to orient primers for fast, easy handling and primer pick-up with the primer feed tubes.

First, scatter the primers onto the grooved surface of the primer tray. Then, gently shake the tray horizontally until all the primers are positioned anvil side up. Place the cover on the tray and, while holding the tray and cover together, turn the tray upside down. The primers will now be oriented anvil side down for easy pick-up with the appropriate size primer feed tube. See Photo #30. Insert the primer feed tube cotter pin in the cross hole before picking up any primers. It will be removed after the tube is inserted into the priming system.

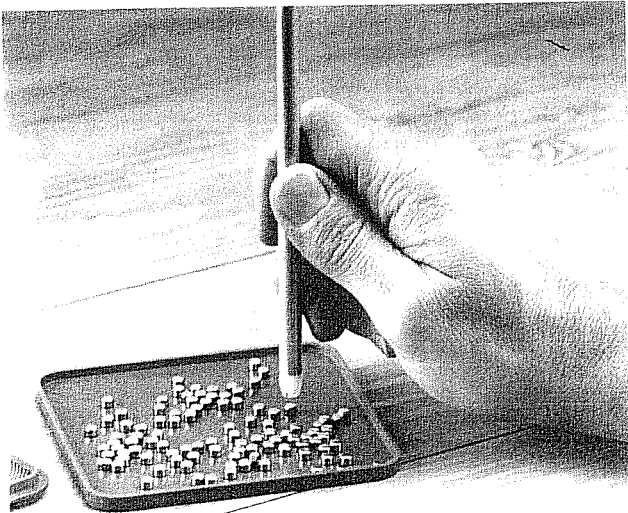

Photo #30: Use an RCBS Primer Tray to correctly position primers for easy pick-up with the primer tube.

⚠ WARNING: It is the responsibility of the operator to insure that all primers are properly oriented. Attempting to seat a primer upside down in a case may cause the primer to detonate causing serious personal injury or damage to the equip-

ment. Primer residue is dangerous when exposed to heat, impact and/or static electricity. Therefore, it is important to keep the primer tubes clean. We recommend periodic cleaning with soap and warm water.

Use the plastic tipped end of the tube opposite the cotter pin for primer pick-up. After filling, insert the tube, cotter pin end down, into the primer dispenser. See Photo #31. The cotter pin can then be removed from the tube. The tube holds 100 primers.

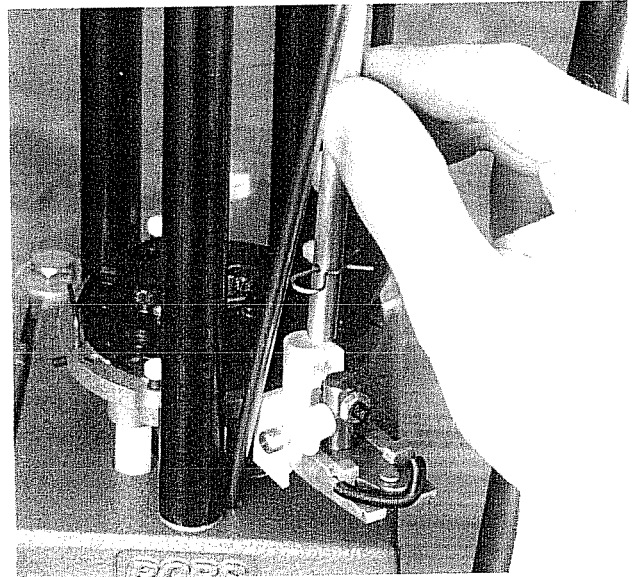

Photo #31: Insert the primer tube into the primer dispenser.

After installing the primer tube in the dispenser, insert the primer follower, small end down, into the top of the tube. See Photo #32. When the last primer is used the primer follower will drop down and alert you to the fact that you are out of primers by locking the transfer bar at the primer dispenser.

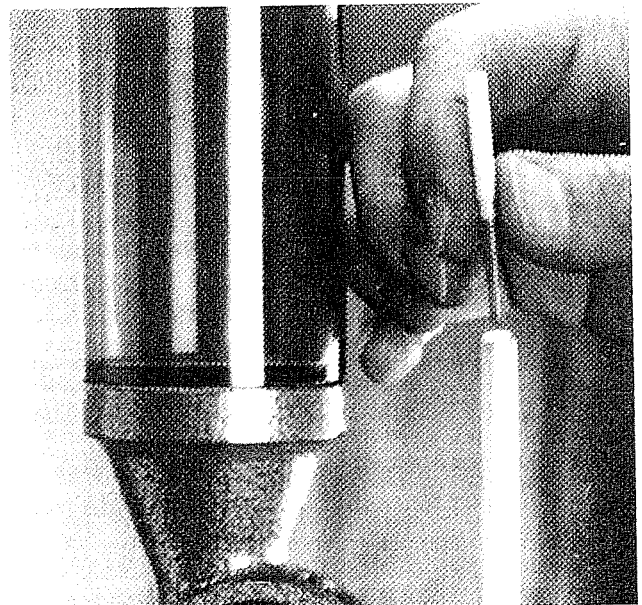

Photo #32: Drop the primer follower into the full primer tube.

PRESS OPERATION

After completing the set-up procedure and becoming familiar with the press operation, the press is ready for use. The following steps are for an AmmoMaster that is set up for auto indexing.

STEP 1

Place a fired case in the shell plate at station #1. Lower the handle and the fired case will enter the sizer die. The case will be sized (lubed, if using a lube die on bottle neck cases) and the spent primer will be ejected. The spent primer will fall through the spent primer tube and into the bottle. As the ram travels upward, the primer transfer bar will pick up a primer from the dispenser. **Be sure the cotter pin is removed from the primer tube.** If you experience a problem at this stage, refer to adjustment #2 on page 8.

STEP 2

Raise the handle. As the case is lowered it will automatically index to station #2. (If manually indexing, rotate the star wheel counter clockwise one station after the case is lowered. Then prime by pushing on the press handle.) As the press is cycling, the primer transfer bar will deliver a primer to the primer station. The design of the tool allows you to see the primer being transferred. You can confirm that the primer is anvil-side-up. Develop the habit of watching the transfer bar with each pull of the handle. Use a firm force to seat the new primer into the deprimed case. Using a smooth consistent stroke, with a pause at the top of the handle travel before seating the primer, will help develop the ability to "feel" the proper primer seating. Remember, priming is done in the top few inches of handle travel.

NOTE: Developing the ability to "feel" a primer being seated is one of the most important traits of an experienced reloader. This ability not only assures proper seating depth but also makes you aware if something is wrong. If it doesn't "feel" right, stop and check your work.

⚠ WARNING: Do not attempt to prime military cartridge cases with crimped primer pockets until the crimp has been removed by swaging. Primers seated into crimped pockets are subject to deformation which can cause misfires and even detonation during seating which can cause personal injury.

⚠ WARNING: Do not attempt to seat primers against excessive resistance which might cause detonation and possible personal injury. Check to be certain that the case was not previously primed,

that the fired primer was removed, that a portion of the primer cup wall might still be in the primer pocket, and that you are using the correct size primer.

⚠ WARNING: Do not modify the AmmoMaster priming system or parts in any manner or attempt to use similar parts or priming systems from other manufacturers. Do not use the AmmoMaster priming system on any other reloading press. To do so could result in primer detonations resulting in personal injury.

STEP 3

The primer seating depth is adjusted by the primer depth screw on the press base. See Photo #33. Start the adjustment with the screw too high and adjust the



Photo #33: This screw adjusts the primer seating depth.

screw downward until the primers are seated to the correct depth. Pull each case out of the shell plate at the priming station and visually check the depth of the seated primer. Ideally, the primer should be .002" to .004" of an inch below flush. When you are satisfied with the priming depth, ensure the jam nut on the primer depth adjustment screw is tightened.

⚠ WARNING: Do not slam the primer transfer bar. This can cause a primer to detonate, causing serious personal injury.

⚠ WARNING: Primers not seated below flush of the cartridge case head can result in a "slam-fire." This is a condition wherein the cartridge fires inadvertently as the gun mechanism is cycled. A "slam-fire" can result in serious personal injury and equipment damage.

NOTE: Pick up any loose primers at once.

STEP 4

After you are satisfied with the primer seating, place another fired case in station #1. Lower the handle and the primed case will enter the die in station #2. As the handle is raised and the shell plate is lowered, the case automatically indexes to the powder dispensing station. Don't forget to seat the next primer at station #2.

⚠ WARNING: When using manual index, care should be taken not to double charge a case. Remember, the case does not advance until you turn the star wheel.

STEP 5

Place a fired case into station #1. By lowering the handle again, the first case will enter the powder measure adaptor. The powder will automatically be dispensed into the case. As the shell plate is lowered the case will index to the next station.

NOTE: This is an excellent time to pull the case from the shell plate and check the powder charge on an accurate reloading scale. Replace the powder in the case and return the case to station #4 in the shell plate.

STEP 6

Place a fired case into station #1. Raising the handle, the case at station #4 will enter a die (depending on die configuration). As the shell plate is lowered the case will index to station #5.

STEP 7

NOTE: Take time to adjust the case eject spring. The case eject spring should be lowered as close to the shell plate as possible without touching it. The case eject spring should be angled to contact the case near the end of the spring but not interfere with movement of the star wheel if manually indexing. See Photo #34.

Place a fired case into station #1. As the shell plate is raised the case at station #5 will enter the bullet seating die (sometimes the crimp die). Hold a bullet on top of the case and guide it into the seater die. As the shell plate is lowered, the case moves to the case eject spring. The case eject spring will push the loaded round into the ammo catcher box, mounted on the side of the base.

NOTE: Take the reloaded cartridge and examine the primer seating depth and the crimp on the bullet. Examine each cartridge until fully satisfied with each operation performed by the press.

NOTE: Remember that each step is performed with each cycling of the press. Go slow at first until you are comfortable and satisfied with each operation of the press. Safety is more important than speed.

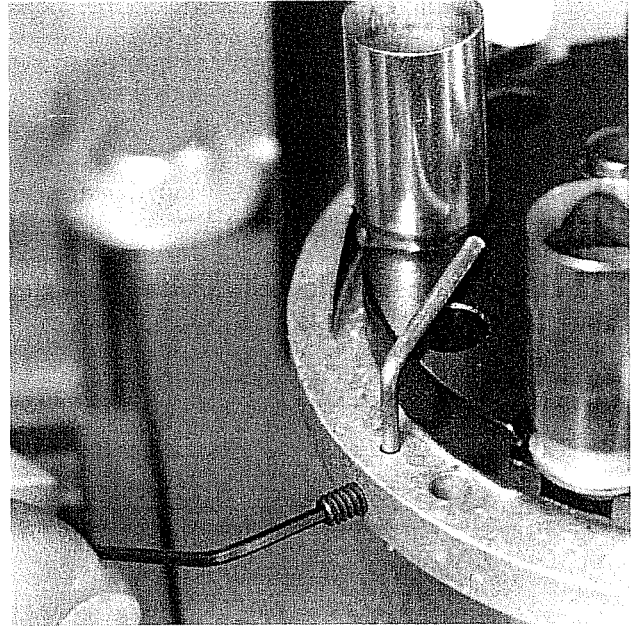
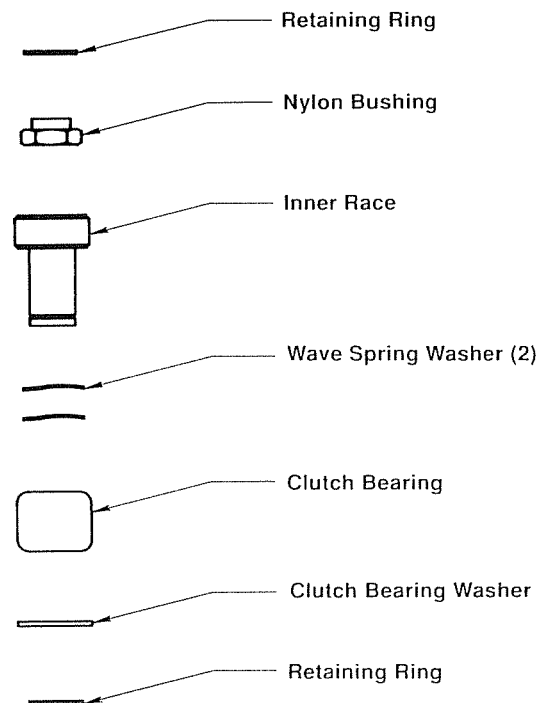

Photo #34: Take time to properly adjust the case eject spring.

NOTE: If the handle is forced when there is a jam with the shell plate, you may damage the nylon index bushing. If the bushing becomes damaged, you will notice that the shell plate will either not index completely or not index at all. A spare bushing is included with your press and will need to be replaced if it becomes damaged. To remove a damaged bushing, use a small screw driver or a sharp tool to remove the retaining ring from the top of the bushing. Push the damaged bushing out from the bottom and press the new bushing into place. To reinstall the retaining ring, place it on top of the indexing system and press it straight down to snap it into place.



HELPFUL HINTS

- Develop the habit of watching the transfer bar move from the primer tube to the priming station. This will confirm that the primer is in place and anvil side up.
- Starting with an equal amount of primers and bullets (such as a box of 100 primers and a box of 100 bullets) you will know how many primers you have in the primer tube by the number of bullets you have remaining.
- Box the reloaded ammunition in an orderly manner. Avoid dumping the loaded rounds into a large container. An occurrence such as an empty powder measure will not affect an entire lot.
- **Reload alone. Do not allow anyone or anything distract you.**
- **If you have the slightest doubt whether a particular round contains powder, set it aside. An empty round cannot necessarily be detected by weighing or shaking. Take no chances! Pull the bullet if you have any doubt.**
- Develop the habit of running your finger across the case head while boxing the reloaded ammunition. A primer protruding as little as .001 of an inch can be detected by feel, with practice.
- Save these instructions for future reference.
- Keep the AmmoMaster and the reloading area neat and clean. This will help insure good operation of the tool. A can of canned air, such as OUTERS® Grit Getter™, can be helpful in cleaning hard to reach areas of the tool.
- Be sure to cycle the handle all the way up and all the way down. Remember, primer seating takes place in the top few inches of the handle travel. There will be a slight resistance in this position.
- The primer dispenser must be firmly seated on the shell plate holder. If raised even slightly, primers will hang-up under the primer dispenser or fail to feed.
- If the primer dispenser becomes loose, bend the small legs inward to tighten the grip on the shell plate holder.
- If the primer dispenser appears to be tipped during reloading, this may be due to an improperly adjusted transfer bar. See page 7 for adjustment instructions.
- Remember, the key to reloading with any press is to develop a smooth, fluid stroke. Never force any reloading equipment.

TROUBLE SHOOTING

Refer to this section for help in solving any specific problems you might encounter while operating the AmmoMaster. If you need additional help, refer to the phone numbers on the back of this manual. Call us at the factory and we'll be glad to help. Many times, a problem can be solved over the phone.

Shell Plate does not rotate:

- Fired primer not pushed clear of the shell plate.
- Fired primers stacked in depriming tube.
- Dirt or debris under the shell plate.
- Primer plug stuck in case at station #2. Clean debris from under primer plug or check timing.

Shell Plate does not rotate completely:

- Damaged index bushing. Refer to index bushing replacement section on page 20.
- Travel of the index rod only partially through the twist (short handle stroke).
- Check the position of the locating pin.

Primer seated upside down or sideways:

- Primer picked up wrong when primer tube was loaded.
- Incorrect primer transfer bar installed.
- Primer transfer bar not properly adjusted.
- Incorrect primer tube.

Deformed primer during seating:

- Using military case with crimped primer pocket.
- Wrong primer size.
- Incorrect primer plug and primer transfer bar.
- Primer transfer bar not properly adjusted.

Primer transfer bar did not pick up a primer:

- Empty primer tube.
- Wrong primer size.
- Primer transfer bar not properly adjusted.
- Incorrect primer dispenser.
- Wrong transfer bar.

Spilled powder at station #3:

- Wrong or absence of powder drop tube.
- Powder drop tube installed upside down.
- Powder measure adaptor needs cleaning.
- Excessive powder charge.
- Lowering the ram too fast.
- Shell plate not indexed correctly.
- Powder selection not suited for the AmmoMaster.
- Powder level too close to the case mouth.
- Abrupt indexing.
- The powder measure return spring must not touch the connecting yoke.

Fired case hangs up trying to enter sizer die:

- Case not fully inserted into shell plate.
- Inadequate entry chamfer on die (common to older dies).

- Debris in the shell plate.
- Priming system will not seat primers:
- Primer depth screw not properly adjusted.
 - Incomplete indexing. Check the position of the locating pin.
 - Incorrect transfer bar adjustment at the shell plate.
 - Primer has dropped in front of transfer bar, therefore restricting travel.
 - Some priming problems can be associated with older style primers.

- Primer transfer bar fails to move freely:
- Accumulation of dirt in the transfer bar slot.
 - Accumulation of dirt under the plug.

CARE AND MAINTENANCE

This press was lubricated when assembled at the factory. However, it is necessary to lightly lubricate most moving parts from time to time with a light oil such as OUTERS® Gun Oil. If rust spots appear, swab lightly with gun oil and wipe dry. Care should be taken not to apply oil where it could come in contact with primer pockets or primers. Oil will deactivate primers. It is a good practice to clean the press prior to lubrication to remove grit and other residue. You will note the ease at which the epoxy enamel paint wipes clean. This finish is impervious to oil and is extremely chip and fade resistant. Remember, if you need technical assistance or reloading information, just give us a call. Our toll-free and regular phone numbers are listed on the back of this instruction manual. ~

Use the following information as well as the care and maintenance instructions that came with your reloading dies.

- Keep the AmmoMaster clean at all times.
- Promptly clean up any powder spills.
- Remove any spilled powder from under the shell plate.
- Keep the priming station clear of any foreign objects.
- Occasionally oil the ram.
- Develop the habit of thoroughly cleaning the AmmoMaster and the powder measuring system every 500 rounds.

 **WARNING: Primer and powder residue is dangerous when exposed to heat, impact and/or static electricity.**

CALIBER CHANGE-OVER CHECK LIST

Changing calibers on the AmmoMaster is really quite simple. Here is a list of steps that may be required to change the AmmoMaster from one caliber to another.

- Remove the reloading die set and replace with the new caliber.
- Change the shell plate, if necessary.
- Change the primer dispenser, primer plug, transfer bar, and primer tube if necessary.
- Adjust the primer seating height if necessary.
- Check the adjustment of the primer transfer bar.
- Remove the powder drop tube from the powder measure adaptor and replace with the correct size.
- Adjust the powder measure to dispense the correct powder charge. Be sure to use an accurate reloading scale to weigh the new powder charge.
- Adjust the case eject spring.

| CALIBER | SHELL PLATE NUMBER | PART NUMBER | CALIBER | SHELL PLATE NUMBER | PART NUMBER |
|-------------------------------|--------------------------|----------------|-----------------------------|--------------------------|----------------|
| .17 Remington | 10 | 88810 | .307 Winchester | 2 | 88802 |
| .218 Bee | 1 | 88801 | .308 Norma Magnum | 4 | 88804 |
| .22 Hornet | 12 | 88812 | .308 Winchester | 3 | 88803 |
| .22K-Hornet | 12 | 88812 | 7.5mm Schmidt-Rubin | 2 | 88802 |
| .22 PPC | 32 | 88832 | 7.62mmx39-.308/.311 | 32 | 88832 |
| .22 Remington Jet | 6 | 88806 | 7.62mmx54R Russian | 13 | 88813 |
| .22 Savage High-Power | 2 | 88802 | 7.65mmx53 Belgian Mauser | 3 | 88803 |
| .22-250 | 3 | 88803 | 7.7mmx58 J. Arisaka | 3/2 | 88803/88802 |
| .220 Swift | 11 | 88811 | .32 Auto (7.65mm Auto) | 17 | 88817 |
| .221 Remington Fire Ball | 10 | 88810 | .32 H&R Magnum | 23 | 88823 |
| .222 Remington | 10 | 88810 | .32 Smith & Wesson Long | 23 | 88823 |
| .222 Remington Magnum | 10 | 88810 | .32 Winchester Special | 2 | 88802 |
| .223 Remington (5.56mm) | 10 | 88810 | .32-20 Winchester | 1 | 88801 |
| .224 Weatherby Magnum | 27 | 88827 | .32-40 Winchester | 2 | 88802 |
| .225 Winchester | 11 | 88811 | 8mm Remington Magnum | 4 | 88804 |
| 5.6mmx50 Rimmed | 6 | 88806 | 8mm-06 | 3 | 88803 |
| .240 Weatherby Magnum | 3 | 88803 | 8mmx57 Mauser (8mm Mauser) | 3 | 88803 |
| .243 Winchester | 3 | 88803 | 8mmx68S Magnum | 34 | 88834 |
| 6mm PPC | 32 | 88832 | .33 Winchester | 14 | 88814 |
| 6mm Remington (.244 Rem) | 3 | 88803 | .338 Winchester Magnum | 4 | 88804 |
| .25-06 | 3 | 88803 | .340 Weatherby Magnum | 4 | 88804 |
| .25-20 Winchester | 1 | 88801 | .348 Winchester | 5 | 88805 |
| .25-35 Winchester | 2 | 88802 | .35 Remington | 9 | 88809 |
| .250 Savage (250-3000 Savage) | 3 | 88803 | .35 Whelen | 3 | 88803 |
| .256 Winchester Magnum | 6 | 88806 | .350 Remington Magnum | 4 | 88804 |
| .257 Roberts | 11 | 88811 | .356 Winchester | 2 | 88802 |
| .257 Roberts Improved 40° | 11 | 88811 | .357 Herrett | 2 | 88802 |
| .257 Weatherby Magnum | 4 | 88804 | .357 Magnum | 6 | 88806 |
| .264 Winchester Magnum | 4/26 | 88804/88826 | .357 Remington Maximum | 6 | 88806 |
| 6.5mm Remington Magnum | 4 | 88804 | .358 Norma Magnum | 4 | 88804 |
| 6.5mm T/CU | 10 | 88810 | .358 Winchester | 3 | 88803 |
| 6.5mm-06 | 3 | 88803 | 9mm Luger | 16 | 88816 |
| 6.5mmx50 J. Arisaka | 15 | 88815 | 9mm Makarov | 16 | 88816 |
| 6.5mmx52 Carcano | 9 | 88809 | 9mmx21 | 16 | 88816 |
| 6.5mmx54 Mann.-Sch | 9 | 88809 | 9.3mmx62 Mauser | 3 | 88803 |
| 6.5mmx55 Swedish Mauser | 2 | 88802 | 9.3mmx72R | 30 | 88830 |
| 6.5mmx57 | 3 | 88803 | 9.3mmx74R | 4 | 88804 |
| .270 Weatherby Magnum | 4 | 88804 | .375 H&H Magnum | 4 | 88804 |
| .270 Winchester | 3 | 88803 | .375 Winchester | 2 | 88802 |
| .280 Rem (7mm Exp Rem) | 3 | 88803 | .378 Weatherby Magnum | 14 | 88814 |
| .284 Winchester | 3 | 88803 | .38 Colt Super Auto | 39 | 88839 |
| 7mm Benchrest Remington | 3 | 88803 | .38 Smith & Wesson | 6 | 88806 |
| 7mm Remington Magnum | 4/26 | 88804/88826 | .38 Special | 6 | 88806 |
| 7mm T/CU | 10 | 88810 | .380 Automatic Pistol | 10 | 88810 |
| 7mm Weatherby Magnum | 4 | 88804 | .38-40 Winchester | 35 | 88835 |
| 7mm-08 Remington | 3 | 88803 | .38-55 Winchester & Ballard | 2 | 88802 |
| 7mmx57 Mauser (7mm Mauser) | 11/3 | 88811/88803 | .40 S&W | 27 | 88827 |
| 7mmx64 Brenneke | 3 | 88803 | 10mm Auto | 27 | 88827 |
| 7mmx65 Rimmed | 26 | 88826 | .41 Action Express | 16 | 88816 |
| 7-30 Waters | 2 | 88802 | .41 Magnum | 30 | 88830 |
| .30 M-1 Carbine | 17 | 88817 | .416 Remington Magnum | 4 | 88804 |
| .30 Herrett | 2 | 88802 | .416 Rigby | 37 | 88837 |
| .30 Luger (7.65mm Luger) | 16 | 88816 | .44 Magnum | 18 | 88818 |
| .30 Mauser (7.63mm Mauser) | 16 | 88816 | .44 Special | 18 | 88818 |
| .30 Remington | 19 | 88819 | .444 Marlin | 28 | 88828 |
| .30-06 Springfield | 3 | 88803 | .44-40 Winchester | 35 | 88835 |
| .30-30 Winchester | 2 | 88802 | .45 Auto (.45 ACP) | 3 | 88803 |
| .30-338 Winchester Magnum | 4 | 88804 | .45 Auto Rim | 8 | 88808 |
| .30-40 Krag | 7 | 88807 | .45 Colt | 20 | 88820 |
| .300 H&H Magnum | 4 | 88804 | .45 Winchester Magnum | 36 | 88836 |
| .300 Savage | 3 | 88803 | .45-70 U.S. Government | 14 | 88814 |
| .300 Weatherby Magnum | 4 | 88804 | .458 Winchester Magnum | 4 | 88804 |
| .300 Winchester Magnum | 4/26 | 88804/88826 | .460 Weatherby Magnum | 14 | 88814 |
| .303 British | 7 | 88807 | .50 Action Express | 33 | 88833 |
| .303 Savage | 21 | 88821 | .50-70 U.S. Government | 31 | 88831 |

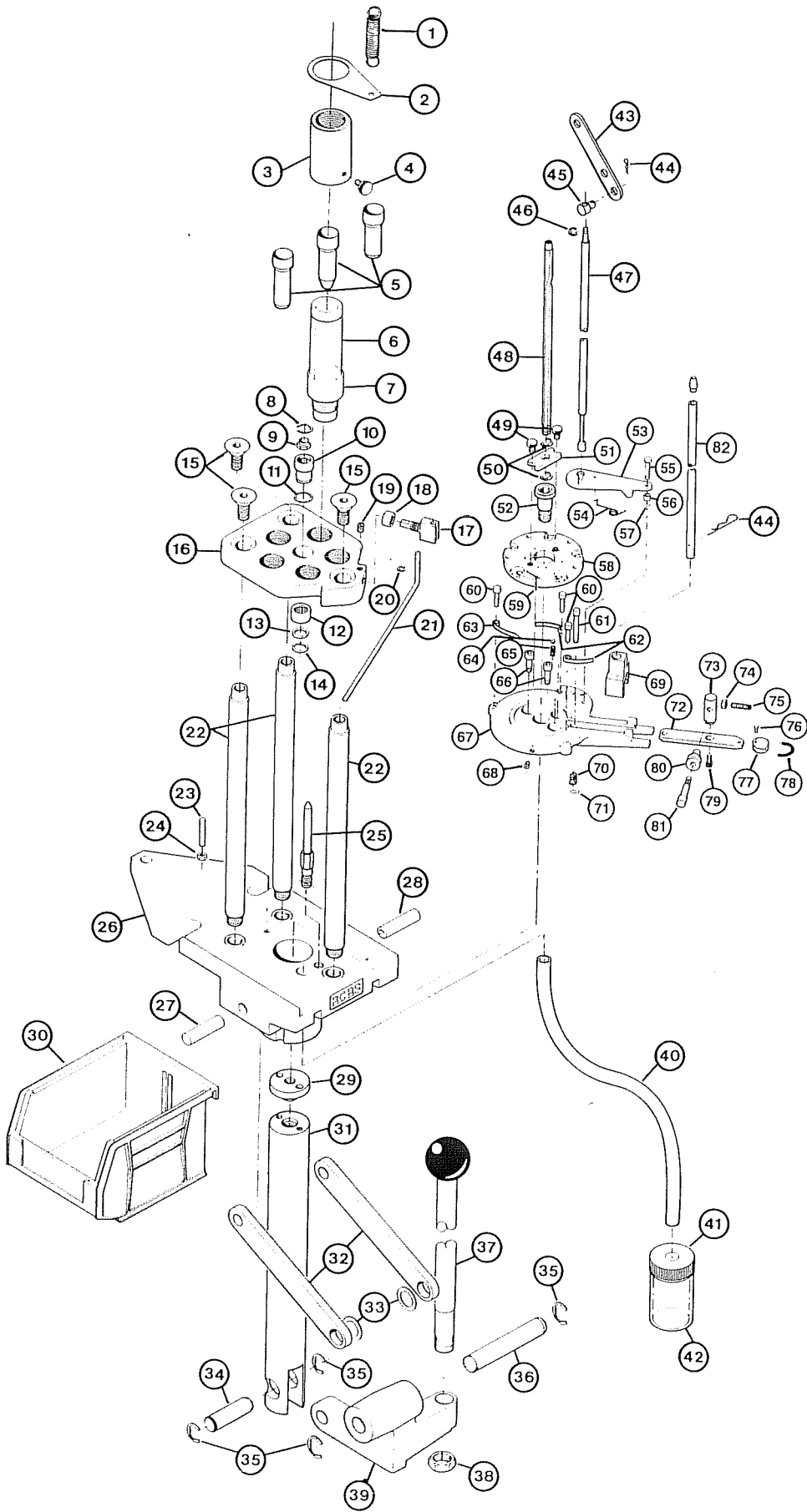

AMMOMASTER-AUTO PROGRESSIVE RELOADING PRESS PARTS LIST

| KEY | PART # | DESCRIPTION | KEY | PART # | DESCRIPTION |
|-----|---------|------------------------------|-----|---------|-------------------------------------|
| 1 | 88753 | Powder Measure Return Spring | 50 | 87657 | Retaining Ring (2) |
| 2 | 88757 | Return Spring Tab | 51 | 88003 | Connecting Plate |
| 3 | 88724 | Quick Change Collar | 52 | 88009 | Shoulder Bolt |
| 4 | 88052 | Collar Lock Screw | 53 | 88726 | Case Detection Arm |
| 5 | 88736 | Small Rifle Drop Tube | 54 | 88729 | Case Detect Spring |
| 5 | 88735 | Large Rifle Drop Tube | 55 | 88728 | Case Detect Arm Pin |
| 5 | 88734 | Pistol Drop Tube | 56 | 88738 | Detection Arm Pin Sleeve |
| 6 | 88723 | Powder Measure Adaptor Tube | 57 | 88754 | Retaining Ring |
| 7 | 88739 | Powder Measure Male Adaptor | 58 | — | Five Station Shell Plate |
| 8 | 87654 | Retaining Ring | 59 | 88038 | Case Eject Spring |
| 9 | 87650 | Nylon Index Bushing (2) | 60 | 88717 | Case Retaining Spring Plug (3) |
| 10 | 87651 | Inner Race | 61 | 7-88797 | Primer Plug-2, Large |
| 11 | 87652 | Wave Washer | 61 | 7-88796 | Primer Plug-2, Small |
| 12 | 87653 | Clutch Bearing | 62 | 88751 | Station 2 & 4 Case Retaining Spring |
| 13 | 87658 | Roller Clutch Washer | 63 | 88752 | Station 5 Case Retaining Spring |
| 14 | 09143 | Retaining Ring | 64 | 87152 | Index Ball |
| 15 | 88032 | 3/8 - 16 x 1" FHSS (3) | 65 | 88037 | Index Ball Spring |
| 16 | 88001 | Top Plate | 66 | 87159 | 1/4 - 28 x 3/4 Cap Screw (2) |
| 17 | 88026 | Cam Wire Clip | 67 | 88786 | Shell Plate Holder |
| 18 | 88027 | 3/8 - 24 Hex Nut | 68 | 09509 | Setscrew, 8-32 x 1/4 |
| 19 | 09099 | 10 - 32 x 1/4 Setscrew | 69 | 88044 | Primer Dispenser, Small |
| 20 | 87670 | Retaining Ring | 69 | 88045 | Primer Dispenser, Large |
| 21 | 7-88692 | Cam Wire-2 | 70 | 88014 | Primer Plug Spring |
| 22 | 7-88691 | Support Rod-2 (3) | 71 | 88042 | Primer Plug Clip |
| 23 | 88033 | 1/4 - 28 x 1/4 Setscrew | 72 | 88015 | Transfer Bar, Small |
| 24 | 87175 | 1/4 - 28 Lock Nut | 72 | 88016 | Transfer Bar, Large |
| 25 | 88718 | Index Locating Pin | 73 | 88021 | Roller Carrier (2) |
| 26 | 88710 | Base | 74 | 88035 | 8 - 32 Hex Nut (2) |
| 27 | 09127 | Link Pin, Left | 75 | 88034 | 8 - 32 x 3/4 SHSS |
| 28 | 09128 | Link Pin, Right | 76 | 88018 | Spring Retainer Rivet (2) |
| 29 | 88716 | Shell Plate Holder Adaptor | 77 | 88017 | Spring Retainer (2) |
| 30 | 88031 | Ammo Catcher Box | 78 | 88019 | Return Spring |
| 31 | 88714 | Ram | 79 | 87687 | 10 - 32 x 1/4 Cap Screw (2) |
| 32 | 88719 | Linkage Arms (2) | 80 | 88020 | Cam Rollers (2) |
| 33 | 09144 | Bow Washer (2) | 81 | 88737 | Roller Pins (2) |
| 34 | 87166 | Ram Pin | 82 | 09582 | Primer Tube, Small |
| 35 | 09105 | 1/2" Retaining Ring (4) | 82 | 09581 | Primer Tube, Large |
| 36 | 88712 | Toggle Block Pin | | | |
| 37 | 7-88693 | Handle-2 | — | 7-88696 | Primer Bushing-2 |
| 38 | 09136 | Handle Lock Nut | — | 7-88697 | Shell Plate Holder Boss-2 |
| 39 | 7-88695 | Toggle Block-2 | — | 88048 | Primer Follower |
| 40 | 88733 | Spent Primer Tube | — | 87501 | Hex Lock Rings 7/8 - 14 |
| 41 | 87178 | Spent Primer Bottle Cap | — | 88051 | Hex Key Wrench .050 |
| 42 | 87177 | Spent Primer Bottle | — | 09534 | Hex Key Wrench 5/64 |
| 43 | 88756 | Cylinder Handle | — | 09635 | Hex Key Wrench 3/32 |
| 44 | 09599 | Cotter Pin (2) | — | 86796 | Hex Key Wrench 5/16 |
| 45 | 87679 | Connecting Yoke | — | 88799 | Die Plate Assembly |
| 46 | 87670 | Retaining Ring | | | |
| 47 | 7-88694 | Case Detection Push Rod-2 | | | |
| 48 | 7-88690 | Index Rod-2 | | | |
| 49 | 88720 | 8 - 32 Knurled Screw (2) | | | |

Refer to the Uniflow Powder Measure Instructions for an exploded view and parts list for the powder measure.

Use this drawing as a template for drilling the holes to mount the AmmoMaster. The press must be securely bolted to a sturdy bench. The bolts must reach through the bench and be secured with washers and hex nuts. Failure to do so can result in equipment damage or serious personal injury.

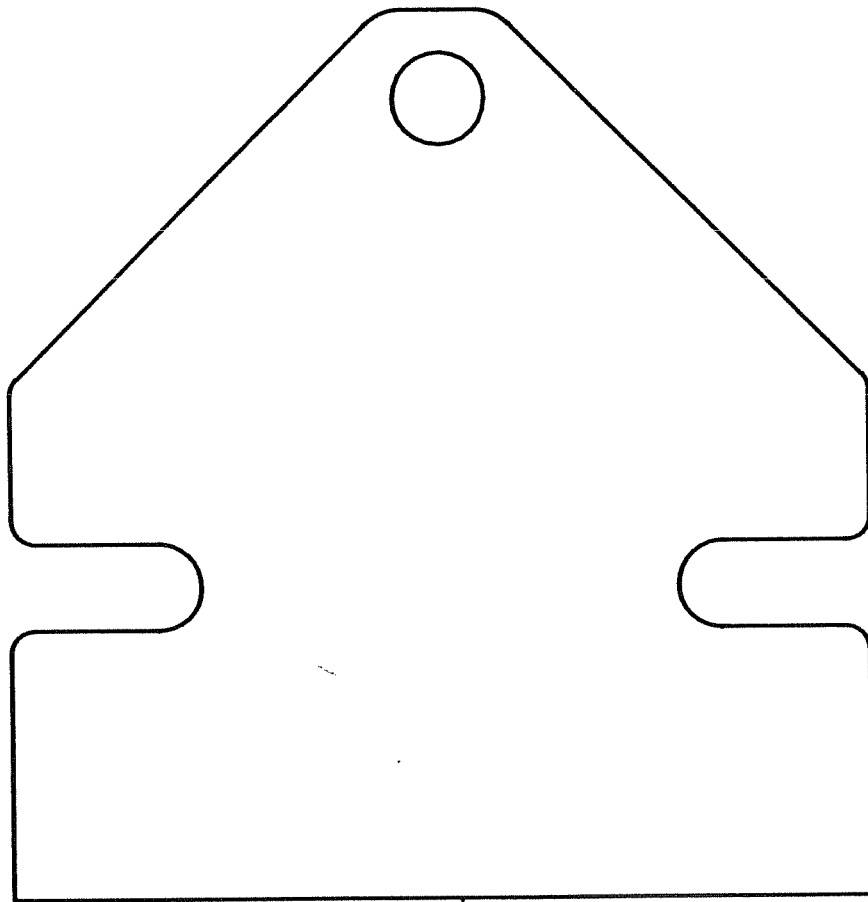

TABLE EDGE



**Supplement to
Instruction Book for
RCBS AmmoMaster-Auto**

The return spring currently installed on the AmmoMaster-Auto Progressive Reloading Press is different than the one shown in photo #24 on page 15 of the instruction book. Use the following instructions and photographs for information about the new spring.

The new Powder Measure Return Spring is designed to improve the function of the powder measure by providing a positive return on the cylinder. The spring now wraps around the powder measure and over the metering screw bushing. Both ends of the spring attach to the return spring tab (part #88757)

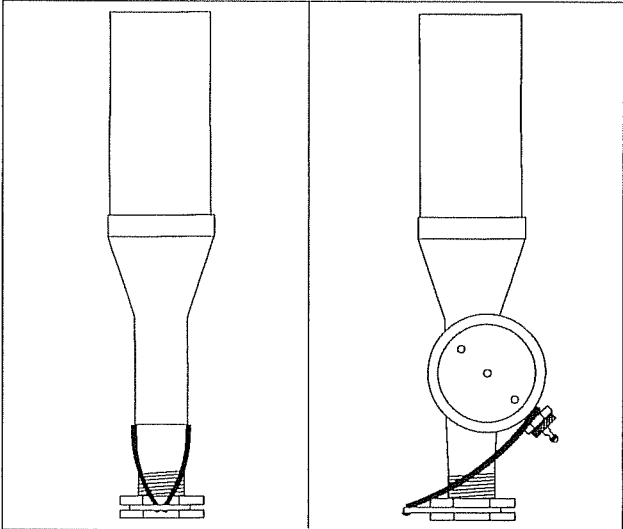
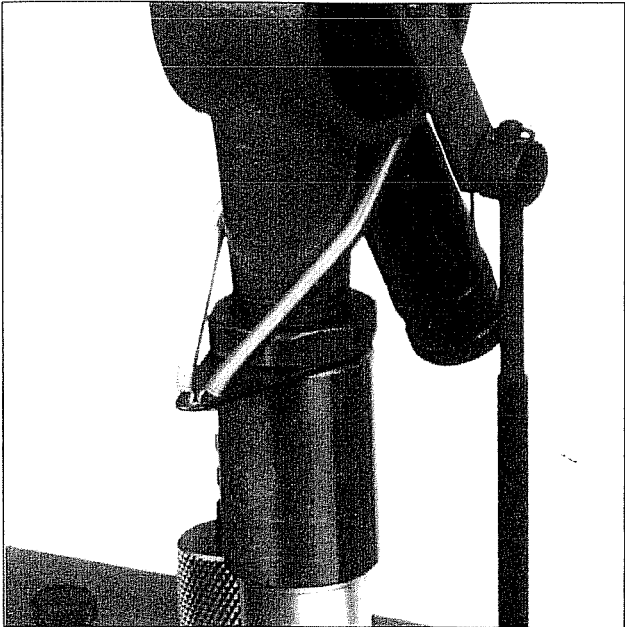



We think that we make the very best
reloading equipment in the world.
If you agree, please tell your friends.
If you disagree, tell us -
we want to do something about it!

Customer Service

1-800-533-5000 *(US or Canada)*

530-533-5191 *(elsewhere)*

Hours: Monday - Friday, 6:30am - 4pm Pacific Time

BLOUNT, INC.

SPORTING EQUIPMENT GROUP

RCBS Operations • 605 Oro Dam Blvd. • Oroville, CA 95965

200450/0499

BLOUNT

FEDERAL • CCI • SPEER • RCBS • OUTERS • WEAVER
RAMLINE • SIMMONS • ORBEX • REDFIELD